

The cover features a dark blue background with abstract, overlapping geometric shapes in various shades of green and light green. These shapes are primarily located in the top right and bottom right corners, creating a modern, dynamic feel. The text is centered in a white, sans-serif font.

TRIANGLE STRATEGIC TOLLING STUDY

FINAL REPORT

October 2019



TABLE OF CONTENTS

1	EXECUTIVE SUMMARY	1
2	INTRODUCTION	7
2.1	Background	7
2.1.1	Tolling Context.....	7
2.1.2	Tolling Concept.....	8
3	TRIANGLE REGION CONDITIONS AND TRENDS	11
4	BEST PRACTICES	16
4.1	Operating Policy	16
4.1.1	Toll Collection.....	16
4.1.2	Occupancy & Vehicle Eligibility.....	19
4.1.3	Hours of Operation.....	21
4.2	Public Outreach	22
4.2.1	Common Issues.....	22
4.3	Design Considerations	23
4.3.1	Separation & Access.....	24
4.3.2	Signage.....	28
4.3.3	Toll Collection Zone.....	30
4.4	Transit	32
4.4.1	Transit Integration.....	32
4.5	Equity Considerations	36
5	RESULTS OF ANALYSES	41
5.1	Tier 1 Screening	41
5.1.1	Initial Screening.....	41
5.1.2	Second Round of Screening	45
5.2	Tier 2 Corridor Evaluation	49
5.2.1	Evaluation Criteria	49
5.2.2	Corridor Results.....	54
6	STAKEHOLDER ENGAGEMENT	66
6.1	Core Technical Team	66
6.2	Stakeholder Oversight Team	68

6.3	Stakeholder Interviews	69
6.4	Partner and Stakeholder Organization Presentations.....	73
6.5	Website	73
	REFERENCES.....	75
	APPENDIX A: CORRIDOR CROSS-SECTIONS	77
A.1	I-40 West Cross-Sections	77
A.2	I-40 Central Cross-Sections.....	79
A.3	I-40 South Cross-Sections.....	81
A.4	I-440 Cross-Sections.....	82
A.5	I-540 Cross-Sections	83
A.6	US-1/US-64 Cross-Sections.....	84
A.7	I-87 Cross-Sections	86
A.8	NC-147 Cross-Sections	87
A.9	US-70 Cross-Sections.....	88
A.10	Wade Avenue Cross-Sections	90

FIGURES

FIGURE 2-1: TOLL EXPRESS LANES IN U.S.	9
FIGURE 3-1: MAP OF MPO BOUNDARIES AND MAJOR ROADWAYS.....	11
FIGURE 3-2: VEHICLE CONGESTION FORECAST - 2013 BASE YEAR.....	13
FIGURE 3-3: VEHICLE CONGESTION FORECAST - 2045 EXISTING + COMMITTED SCENARIO	13
FIGURE 3-4: VEHICLE CONGESTION FORECAST - 2045.....	14
FIGURE 3-5 2045 PM PEAK TRAVEL TIMES	14
FIGURE 4-1: LANE BASED DECLARATION	18
FIGURE 4-2: NC QUICK PASS E-Z PASS INTERIOR TRANSPONDER	18
FIGURE 4-3: SAMPLE BUFFER SEPARATION, U.S. 36 EXPRESS LANES, DENVER, COLORADO.....	25
FIGURE 4-4: SAMPLE CHANNELIZER SEPARATION WITH HOV DECLARATION ZONE, SR-91 EXPRESS LANES, RIVERSIDE, CALIFORNIA	26
FIGURE 4-5: SAMPLE BARRIER SEPARATION, I-30 EXPRESS LANES, DALLAS, TEXAS	27
FIGURE 4-6: WEAVE-ZONE ACCESS DESIGN	28
FIGURE 4-7: CONTINUOUS ACCESS ON I-35W	28
FIGURE 4-8: EXPRESS LANE ENTRANCE SIGNAGE	29
FIGURE 4-9: VARIABLE MESSAGE SIGNAGE.....	30
FIGURE 4-10: TYPICAL TOLL ZONE DESIGN	31
FIGURE 4-11: I-45 ENFORCEMENT AREA, HOUSTON	31
FIGURE 4-12: IN-LINE BRT STATION ON I-35W EXPRESS LANES, MINNEAPOLIS, MINNESOTA	32
FIGURE 4-13: IN-LINE STATION ON I-110	35
FIGURE 5-1: CONGESTION MAP WITH MTP PROJECTS.....	42
FIGURE 5-2: SPEED REDUCTION WITH MTP PROJECTS.....	42
FIGURE 5-3: CRITICAL CORRIDORS USING REAL TIME DATA	43
FIGURE 5-4: CURRENT CONGESTION AND MTP PROJECTS.....	44
FIGURE 5-5: CURRENT CONGESTION AND MTP TOLL AND MANAGED LANES PROJECTS ONLY	44
FIGURE 5-6: PROJECTS RECOMMENDED FOR FURTHER SCREENING	45
FIGURE 5-7: UPDATED CORRIDORS MAP.....	46

FIGURE 5-8: TOM RESULTS FOR REVENUE PER MILE	47
FIGURE 5-9: TOM RESULTS FOR MINUTES PER MILE	47
FIGURE 5-10: CORRIDORS ADVANCING TO TIER 2 SCREENING	48
FIGURE 5-11: 2045 TRANSIT ROUTES IN TRIANGLE REGIONAL MODEL.....	51
FIGURE 5-12: BUFFERED AREAS OF LOW INCOME POPULATIONS ALONG CORRIDOR INTERSECTIONS	52
FIGURE 5-13: ZONES WITH SIGNIFICANT IMPACT OF MANAGED LANES ON LOW INCOME HOUSEHOLDS	53
FIGURE 5-14: CONCENTRATIONS OF ZONES WITH SIGNIFICANT IIMPACT	54
FIGURE 6-1: WORD CLOUD ON COMMUNITY ISSUES POTENTIALLY IMPACTING THE PERCEPTION OF TOLLING/EXPRESS TOLL LANES IN THE TRIANGLE.....	71
FIGURE 6-2: BIGGEST OPPORTUNITIES FOR IMPROVING THE PERCEPTION OF TOLLING	71
FIGURE 6-3: STRATEGIES FOR MITIGATING THE IMPACTS OR PERCEIVED PROBLEMS WITH TOLLING/EXPRESS LANES.....	72
FIGURE 6-4: POTENTIAL ENVIRONMENTAL BENEFITS/CONCERNS	72
FIGURE 6-5: WEBSITE FOR THE STUDY - WWW.TRIANGLETOLLINGSTUDY.COM	74
FIGURE A-1: EXISTING TYPICAL SECTION	77
FIGURE A-2: CONSTRAINED SECTION.....	77
FIGURE A-3: FULL FEATURE SECTION.....	78
FIGURE A-4: EXISTING TYPICAL SECTION	79
FIGURE A-5: SHOULDER USE (PORTION) SECTION	79
FIGURE A-6: CONSTRAINED SECTION.....	80
FIGURE A-7: FULL FEATURE SECTION.....	80
FIGURE A-8: EXISTING TYPICAL SECTION	81
FIGURE A-9: CONSTRAINED CROSS SECTION.....	81
FIGURE A-10: FULL FEATURE SECTION	81
FIGURE A-11: EXISTING TYPICAL SECTION.....	82
FIGURE A-12: CONSTRAINED SECTION	82
FIGURE A-13: FULL FEATURE SECTION.....	82
FIGURE A-14: EXISTING TYPICAL SECTION.....	83
FIGURE A-15: SHOULDER USE OPTION SECTION .	83
FIGURE A-16: CONSTRAINED SECTION.....	83
FIGURE A-17: FULL FEATURE SECTION.....	83

FIGURE A-18: EXISTING TYPICAL SECTION 84
FIGURE A-19: CONSTRAINED SECTION 84
FIGURE A-20: FULL FEATURE SECTION 85
FIGURE A-21: EXISTING TYPICAL SECTION..... 86
FIGURE A-22: CONSTRAINED SECTION 86
FIGURE A-23: FULL FEATURE SECTION 86
FIGURE A-24: EXISTING TYPICAL SECTION..... 87
FIGURE A-25: CONSTRAINED SECTION 87
FIGURE A-26: FULL FEATURE SECTION..... 87
FIGURE A-27: EXISTING TYPICAL SECTION..... 88
FIGURE A-28: CONSTRAINED SECTION..... 89
FIGURE A-29: FULL FEATURE SECTION..... 89
FIGURE A-30: EXISTING TYPICAL SECTION90
FIGURE A-31: CONSTRAINED SECTION90
FIGURE A-32: FULL FEATURE SECTION90

01 EXECUTIVE SUMMARY

1 EXECUTIVE SUMMARY

STATEMENT OF PRINCIPLES

The purpose of the Triangle Strategic Tolling Study is to develop a strategy for the use of express toll lanes to benefit all travelers regardless of travel mode, residential and employment location, and income level. In a fast growing urban area, implementing toll express lanes has several advantages over the addition of general purpose lanes. Toll lanes provide the option for toll users and transit riders to experience a faster, more reliable travel time, and an opportunity to reduce the number of single-occupancy vehicles. However, the Durham-Chapel Hill-Carrboro Metropolitan Planning Organization (DCHC MPO) is concerned that lower-income persons may be unable to afford the tolls and may lack the financial tools to access the payment system. In addition, transit users may not directly benefit from toll lanes, and the growth in vehicle miles traveled per capita, which adds to greenhouse gas emissions, might continue to increase.

In order to address these equity and environmental concerns, the DCHC MPO will incorporate the following set of principles in its evaluation of express toll lanes:

INCOME AND ECONOMIC EQUITY

- Conduct outreach activities with lower-income households to fully understand the effects, both real and perceived, of toll lanes on lower-income travelers, and address these effects in the detailed planning, design and implementation of toll lanes.
- Study and consider implementing subsidy options for lower-income users.
- Remove financial tool barriers to the toll system by permitting, for example, cash toll accounts and eliminating account maintenance fees for lower-income users.

TRANSIT AND MULTIMODAL TRANSPORTATION

- Permit bus transit providers free use of the toll lanes.
- Dedicate a portion of toll revenues to improve transit service in the corridor.
- Dedicate a portion of toll revenues to implement other transportation improvements within the corridor.
- Coordinate toll facilities and adopted transit plans to incorporate features such as bus access points, park-and-ride lots and bus stations.

ENVIRONMENT

- Set tolling policy to create incentives for increased car-pooling and van-pooling, and closely coordinate that policy with employer, university, local government and institutional commuter programs.

PROGRAMMING

- If the construction of express toll lanes requires conventional local, state or federal funding in addition to the toll revenues, this will be a factor in the MPO's evaluation of the toll lane project. A subsidy like this would only be justified if the project includes a strong benefit to transit or other modes.

REGIONAL COOPERATION

- Coordinate the implementation of these principles with the Capital Area Metropolitan Planning Organization (CAMPO) to ensure that equity and environmental concerns are applied to tolling projects throughout the region.

TRIANGLE STRATEGIC TOLLING STUDY

Executive Summary

Introduction

The Triangle's governmental agencies are working together to enhance freeway reliability, reduce congestion, and improve regional mobility through self-sustaining and equitable funding mechanisms. This study is part of an effort to explore tolling and express toll lane concepts for the region by:

- Evaluating technology, operational structures, and performance measures to evaluate future tolling decisions
- Analyzing impacts of tolling options on the regional multi-modal transportation network

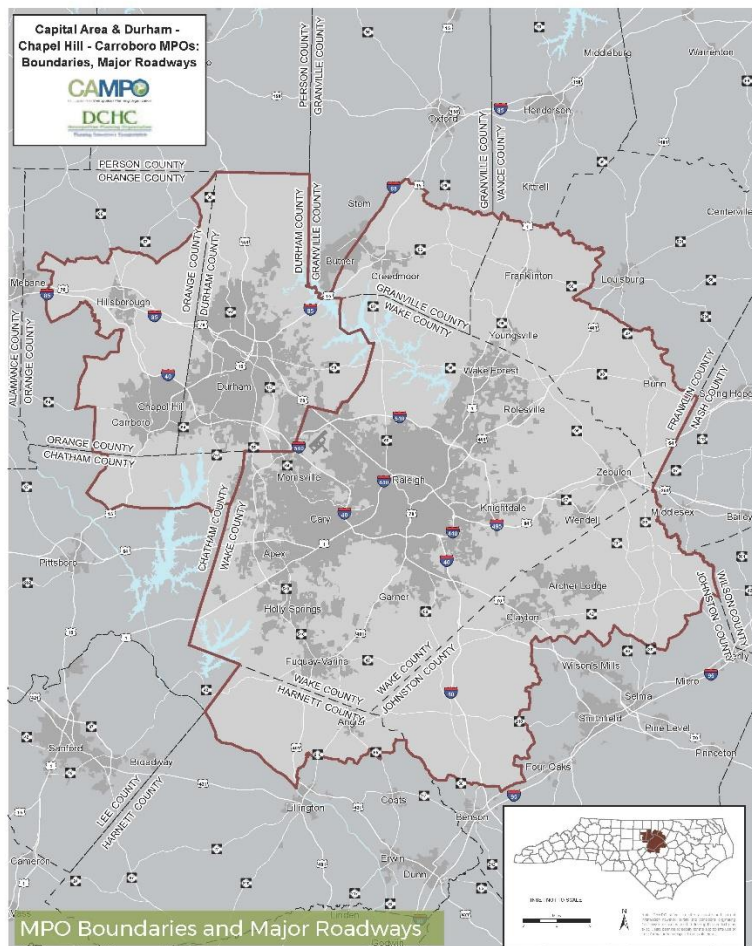

Study Area

Existing and future planned highway facilities within the planning areas of the Capital Area Metropolitan Planning Organization (CAMPO) and the Durham-Chapel Hill-Carrboro Metropolitan Planning Organization (DCHC MPO) were evaluated, as shown in the MPO Boundary map.

The Triangle Region is one of the fastest growing areas in the U.S. creating ongoing challenges for sustainable land use planning, transportation facilities, and resource investments.

As vehicle mileage efficiency improves and motor fuel tax revenues decrease, new ways of funding transportation are needed.

Forecast of Area Growth between 2013 - 2045



Population Growth of 1.28 million



680 thousand New Jobs



278 thousand additional hours in Daily Hours of Delay

Total of area covered by the Triangle Regional Model (TRM)

Express toll lanes are lanes that allow a user to pay a toll for a faster and more reliable travel time. Use of express toll lanes is an option for drivers, not a requirement. On toll lanes, all vehicles are generally tolled, but they may have free or discounted toll use for transit and other specific types of vehicles.

Why Express Toll Lanes?

In growing urban areas such as the Triangle region, new general-purpose lanes only temporarily relieve congestion, especially during rush hours. As growth continues, more drivers will use the same major commuting routes. Highway lanes that usually flow freely during most of the day can come to a standstill as use peaks when many people are trying to get to work or home from a busy day. Given these challenges, this study looks at optional toll roads and express toll lane strategies for a long-term solution for managing congestion for the region. Toll rates that vary in real time ensure toll roads and/or express toll lanes are not overwhelmed, so traffic flows freely in them even during peak demand.

All drivers will benefit from express toll lanes. Each driver decides if the time saved is worth the cost of taking the express toll lanes. Those who choose to take the lanes will save time and avoid congestion. Additionally, the general purpose lanes become less congested when vehicles move onto the express toll lanes. This benefits every vehicle on that stretch of highway. You may use the express toll lanes for short segments, or for the whole length of a trip. Free or discounted toll use for transit also shares the benefit of more reliable schedules for buses while also reducing the number of single occupancy vehicles on the road.

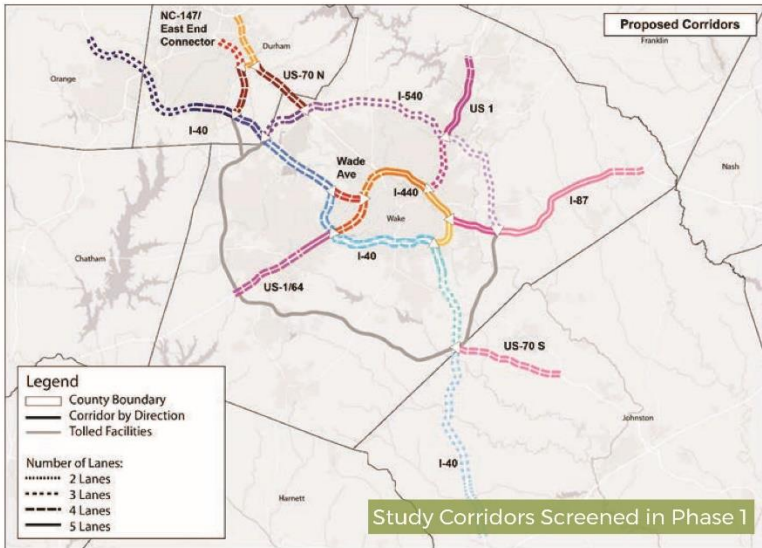

Screening Process

The study approach involved a two-tiered process in which study corridors were screened in the first phase, followed in Phase 2 by a more detailed evaluation of those corridors which showed the most promise for express toll lanes feasibility. The feasibility of express toll lanes in the Triangle region was analyzed by relying on the Triangle Regional Model (TRM) and a toll screening tool.

Peak hour congestion and the difference between free flow and congested speeds were the two screening criteria used in the first round. The second round of screening considered lane volumes, toll revenues, and travel times for express toll lanes. The Stakeholder Oversight Team approved 10 corridor segments to be studied in detail. The metrics below were used to evaluate identified segments.



Travel Time Savings

The estimated time saved during peak periods by express toll lanes users was compared to motorists using the general-purpose lanes.



Revenue and Toll Forecasts

Express lane revenues and user charges were estimated using a Toll Optimization Model, sketch models designed to identify lane volumes and toll levels.



Construction Cost

The costs for implementing express lanes were estimated using a high level cross section design methodology.



Trip Dependability

This factor used the Buffer Time Index developed by the Federal Highway Administration (FHWA). Buffer time is the extra time you must plan for when traveling during high traffic periods to make sure you arrive at your destination on time. Examples include a trip to work, to the airport for a flight, or picking up your child at daycare to avoid a penalty for late arrival.



Transit Supportive

Express toll lanes enhance the speed and effectiveness of corridor transit service. The daily number of buses operating along the express toll lane was estimated based on forecasted route frequency in the TRM.



Access to Jobs

Because express toll lanes create more choices for commuters, the number of jobs projected within a two-mile buffer of each interchange was estimated.



Impact to Low-Income Population

The impacts of the proposed express toll lanes were evaluated by comparing travel times to work made by low-income residents on priced and free lanes.

Corridors Analyzed

The following corridors met the screening criteria and were recommended for detailed study during Phase 2:

- I-40 between NC 54 and US 70
- I-440 between US 1 and I-40
- I-540 between I-40 and I-87
- US-1/US-64 between I-540 and I-40
- I-87 between I-440 and I-540
- NC-147 between Alston Avenue and I-40
- US-70 between NC 147 and I-540
- Wade Avenue between I-40 and I-440

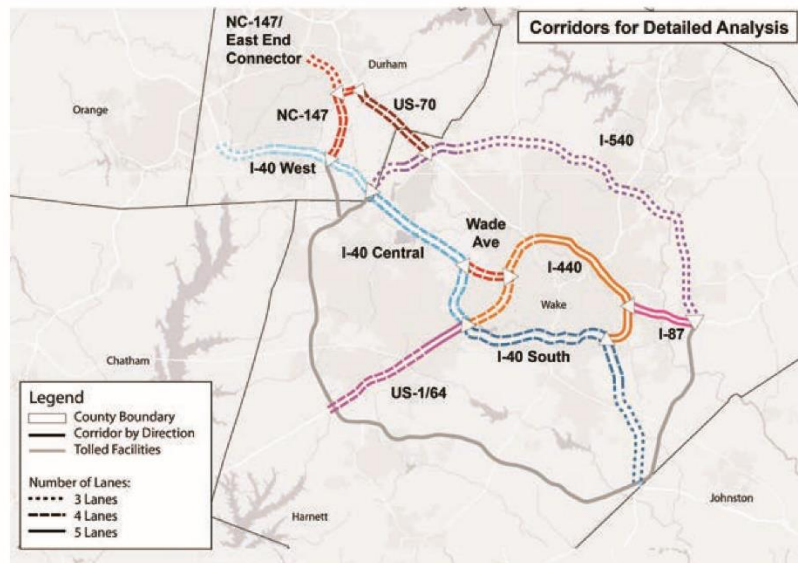

Corridor Results

The Tier 2 evaluation results were summarized in corridor segment fact sheets. An example is shown below.

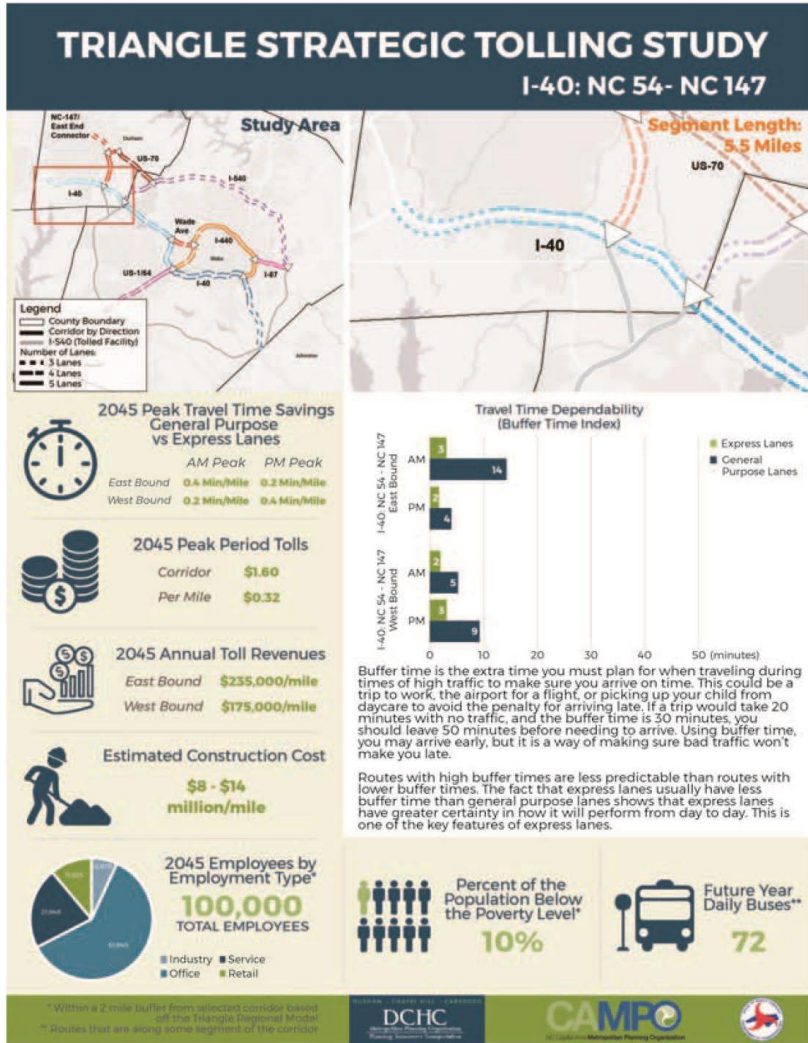

Cross Section Design Considerations

Cost estimates for each segment were prepared using two design approaches:

"Full feature" uses widths preferred by NCDOT for shoulders and lanes and for the buffer separation between express toll lanes and adjacent general-purpose lanes.

"Constrained" uses design exceptions where needed.

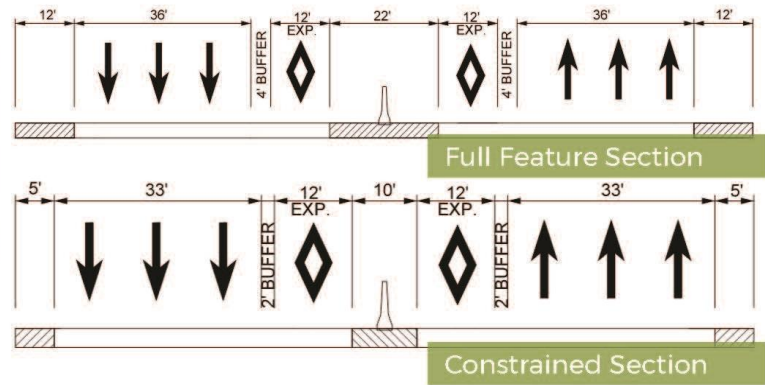

Equity

Although express toll lane initiatives can face equity challenges, all income groups can benefit from the implementation of pricing. Freeway users, even low-income, may benefit indirectly from additional road capacity because toll paying drivers will not be competing for space on existing general-purpose lanes.

One of the most frequent criticisms of express toll lanes is that they primarily benefit high-income drivers who can afford to pay a toll for premium travel. To mitigate these concerns, express toll lane projects in Miami, San Diego, Los Angeles and Atlanta have included policies of targeted revenue allocation for transit service expansion in the priced corridor, discounts for low-income drivers, and opportunities to earn toll credits when traveling on other modes.

Engagement Activities

The primary focus of the study's engagement efforts was to inform key stakeholders about tolling and express toll lanes.

The **Core Technical Team** consisted of 21 members who represented CAMPO, DCHC MPO and NCDOT. The group met four times to review the study's technical products and provide comments.

The **Stakeholder Oversight Team** was comprised of 30 representatives of partner agencies with an interest in transportation planning and capital improvements. This group provided another perspective on the study's technical products and offered new insights during three meetings.



Seven **stakeholder group interviews** were conducted with 25 regional leaders to identify initial perceptions of tolling as a strategy to address mobility problems. Participants were asked a series of questions and responded anonymously through electronic polling to give everyone equal opportunity to provide their input. **Word clouds** show the responses based on the number of times those responses were mentioned or "voted" on by stakeholders.

A **public website** provided project information and allowed the public to communicate with the Study Team.

The study was technical in nature, and as such did not include public interviews or meetings.

However, extensive public engagement would occur during the project development phase of any future proposed toll road or toll lane projects.

For More Information

To find out more about the Triangle Strategic Tolling Study, go to <http://triangletollingstudy.com> or contact:

Kenneth Withrow, AICP
Capital Area MPO
(919) 996-4394
kenneth.withrow@campo-nc.us

Andy Henry, AICP
Durham-Chapel Hill-Carrboro MPO
(919) 560-4366, ext. 36419
andrew.henry@durhamnc.gov

02 INTRODUCTION

2 INTRODUCTION

2.1 BACKGROUND

The Capital Area Metropolitan Planning Organization (CAMPO), the Durham-Chapel Hill-Carrboro Metropolitan Planning Organization (DCHC MPO) and the North Carolina Department of Transportation (NCDOT), with support from the North Carolina Turnpike Authority (NCTA) and other regional partner agencies, explored tolling and managed lane concepts for the Triangle Region. The effort will help to determine existing and future mobility needs for the regional freeway network, and the potential for the implementation of pricing tools to address those needs.

The purpose of the Triangle Strategic Tolling Study was to examine the regional freeway network to identify where tolling or managed lanes policies or actions could improve overall system efficiency. This study:

- Evaluated technology, operational structures, and performance measures to evaluate future tolling decisions.
- Analyzed impacts of tolling options on the regional multi-modal transportation network.

The results of the study will be used to assess the feasibility of and need for using toll roads and/or express toll lanes strategies to achieve regional objectives in the Metropolitan Transportation Plan (MTP).

TOLLING CONTEXT

In 2002, the NCTA was created in response to rapid population growth and the associated increase in congestion that occurred in metropolitan areas throughout North Carolina. The NCTA is authorized by the General Assembly to study, plan, develop, construct, operate, and/or maintain tolling projects throughout the State. Because the Triangle Expressway (NC 540) between Durham and Holly Springs operates in the region, drivers are familiar with general tolling features. However, it also underscores the need for public outreach and education related to priced managed lanes, as the feasibility of such projects are further explored. The I-77 Express Lanes in the Charlotte region, partially opened on June 1, 2019, is the first priced managed lane facility in North Carolina.

The NCTA also oversees the *NC Quick Pass* program, which provides electronic transponders and facilitates toll payments on existing toll facilities. *NC Quick Pass* transponders can be used on NCTA facilities and Georgia priced facilities that utilize the “Peach Pass,” and Florida corridors which use the “Sun Pass” transponder. In addition, NCTA customers can purchase a premium transponder that facilitates access to “E-Z Pass” locations in other states. Any new priced roadway facilities in North Carolina will be incorporated into this existing program. As such, considerations for statewide and regional interoperability will help to frame investigations and strategy development as part of the Triangle Strategic Tolling Study.

TOLLING CONCEPT

The concept of roadway tolling can be applied in many different forms. Although tolling itself currently exists in the Triangle Region, facilities such as priced managed lanes would be new to the area. An understanding of the goals and characteristics of each approach is important as concepts are possibly integrated into a regional tolling strategy. Each tolling approach has a unique intent, with different advantages and disadvantages:

- **Priced Managed Lanes:** Managed lanes such as High-Occupancy Vehicle (HOV) and Bus Only Lanes have existed for decades. Their intent is to limit the number of vehicles in the designated lanes, based on occupancy or vehicle type, to maintain a more desirable level of service relative to adjacent general-purpose lanes. Priced managed lanes, often referred to as High Occupancy Toll (HOT) lanes, integrate pricing to allow toll-paying single-occupancy vehicles (SOV) to use the lanes. However, congestion pricing is used to manage SOV demand during peak traffic periods to ensure that the lane maintains a high level of service and does not become degraded. Qualifying HOVs may use these limited-access lanes for free or at a reduced cost. Drivers in vehicles that do not meet occupancy requirements may choose between the general-purpose lanes or paying for premium conditions in the managed lanes. Priced managed lanes use electronic toll collection and traffic information systems that make it possible to provide variable, real-time toll pricing for non-HOV vehicles. Drivers receive information on price levels and travel conditions via variable message signs, providing potential users with information they need to decide whether to use the managed lanes. In this way, priced managed lanes use price, occupancy, and access restrictions with the goal of maximizing corridor efficiency and person throughput. There are currently 44 variably priced lanes in operation in the United States, with 14 additional facilities under construction in 11 states and Canada (Figure 2-2).
- **Express Toll Lanes (ETL):** ETLs are priced managed lanes where all vehicles, including HOVs, must pay a toll to gain access. Although some traffic performance benefit is intended with this approach, these lanes do not explicitly incentivize ride sharing or person throughput (through discounts or toll-free use) to the extent of HOT lanes. However, tolls may be shared by all occupants of a vehicle, thereby providing an incentive for toll-sharing. Furthermore, to the extent HOV designation is agnostic towards the ability of other passengers to drive separately, ETL's may be almost as effective as HOT lanes towards average vehicle occupancies. Finally, these lanes are easier to enforce than HOV or HOT lanes because there are no occupancy requirements.
- **Bus Toll Lanes (BTL):** BTLs are priced managed lanes where capacity is first dedicated to bus transit. Other vehicles may pay a toll to use the lanes, but performance is maintained by variable pricing to ensure good operating conditions for transit vehicles. These lanes value person-throughput as a higher priority than ETLs and may also be implemented in coordination with transit agencies serving the roadway.

- **Toll Roads:** Traditional toll roads such as the Triangle Expressway (NC 540) charge a toll to all vehicles that enter the highway, not just on designated lanes. Toll roads are often proposed when other funding sources for the roadway are not feasible. Toll roads provide new capacity that can reduce congestion on the overall roadway network.

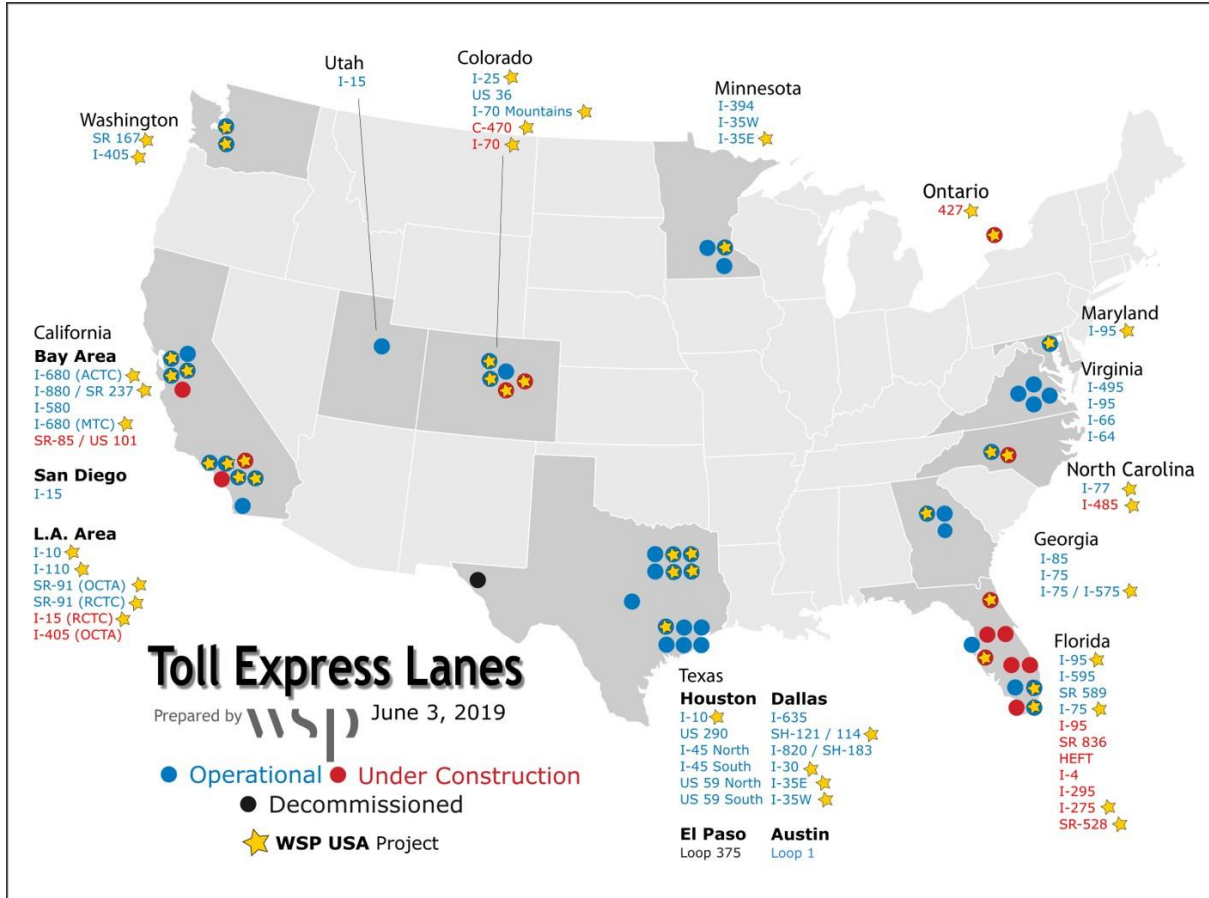

Figure 2-1 Toll Express Lanes in U.S.

03 TRIANGLE REGION CONDITIONS & TRENDS

3 TRIANGLE REGION CONDITIONS AND TRENDS

The Triangle Strategic Tolling Study area includes the planning areas of CAMPO and DCHC MPO. This study evaluates existing and future planned highway facilities included in the counties of Wake County, Durham County, Northeast Chatham County, and portions of Orange County, Franklin County, Granville County, Harnett County, and Johnston County, as shown in Figure 3-1. CAMPO is responsible for transportation planning for the eastern part of the Research Triangle area in North Carolina, while the DCHC MPO encompasses the western portion.

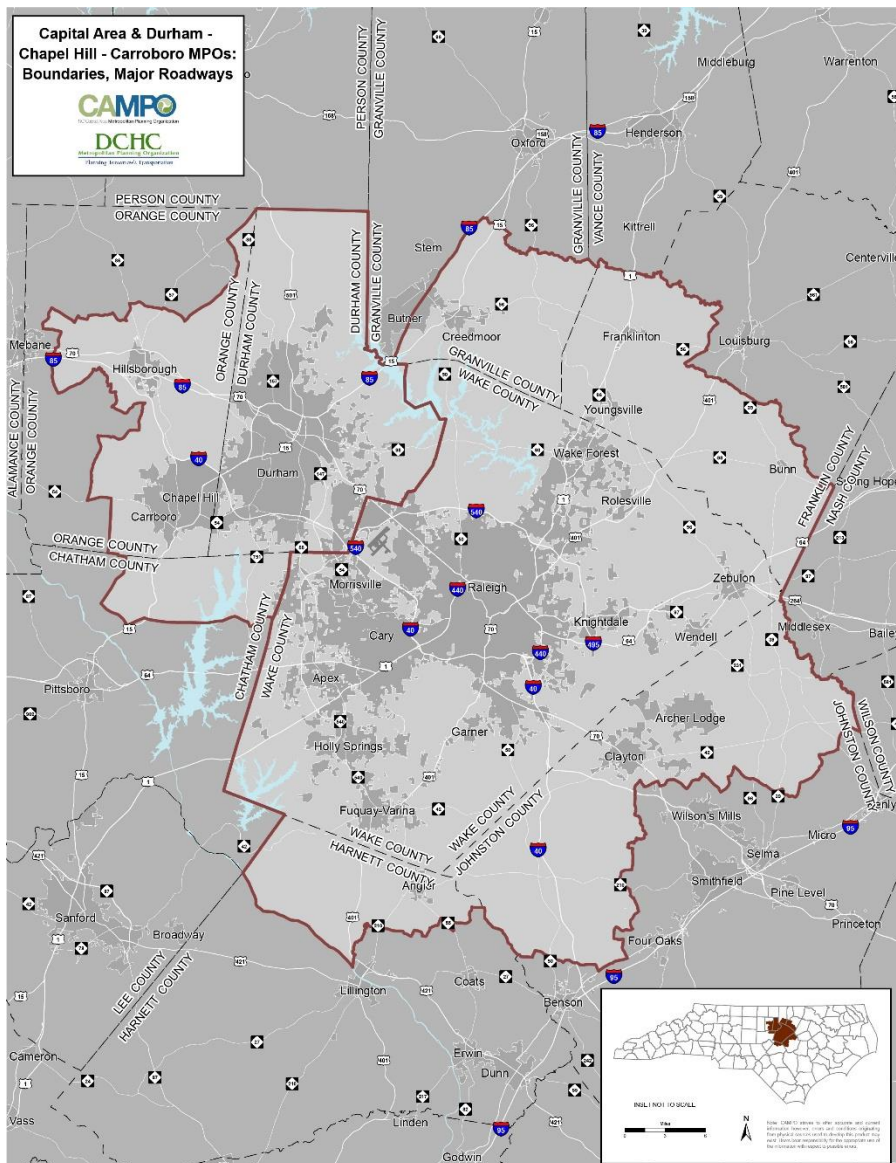

Figure 3-1 Map of MPO Boundaries and Major Roadways

The Triangle Region is one of the fastest growing in the country. This growth creates ongoing challenges for how to plan land use, transportation facilities and resource investments. Many roadways within the Triangle region are near or at capacity. Physical constraints do not always allow new facilities to be constructed. Planned transportation improvements and funding may not be enough to address future regional growth and congestion. CAMPO and DCHC MPO are evaluating options to optimize the performance of the current road infrastructure and methods for developing additional infrastructure given limited funding from the motor fuel tax. It should be noted the current motor fuel tax is not growing due to better vehicle mileage efficiency, therefore new ways of funding transportation improvements are necessary.

As expected growth in the region's population and jobs occur, the amount of travel, measured in Vehicle Miles Traveled (VMT), is expected to grow by over 80 percent. This will add stress on the regional transportation network and is demonstrated by the predicted 2045 levels of congestion.

The following congestion maps show the average volumes during the afternoon peak hours based on projections from the Triangle Regional Model. The 2013 "base year" Congestion Levels map indicates travel conditions in the year 2013, where the 2045 Deficiencies Map, or "Existing plus Committed" (E+C), forecast travel conditions in the year 2045 using the current highway, transit and other transportation facilities, and any facilities that are well on their way to being completed.¹ The third map displays the 2045 MTP congestion map, which presents the levels of congestion if all transportation facilities and services included in the Metropolitan Transportation Plans are provided. The last map shows how far a person could travel from a given location by motor vehicle in a given amount of time during a typical afternoon "rush hour" in the year 2045.

These maps present the challenges the region faces in developing realistic transportation investments that will meet the diverse needs of the region's communities.

¹ CAMPO 2045 Metropolitan Transportation Plan, January 2019

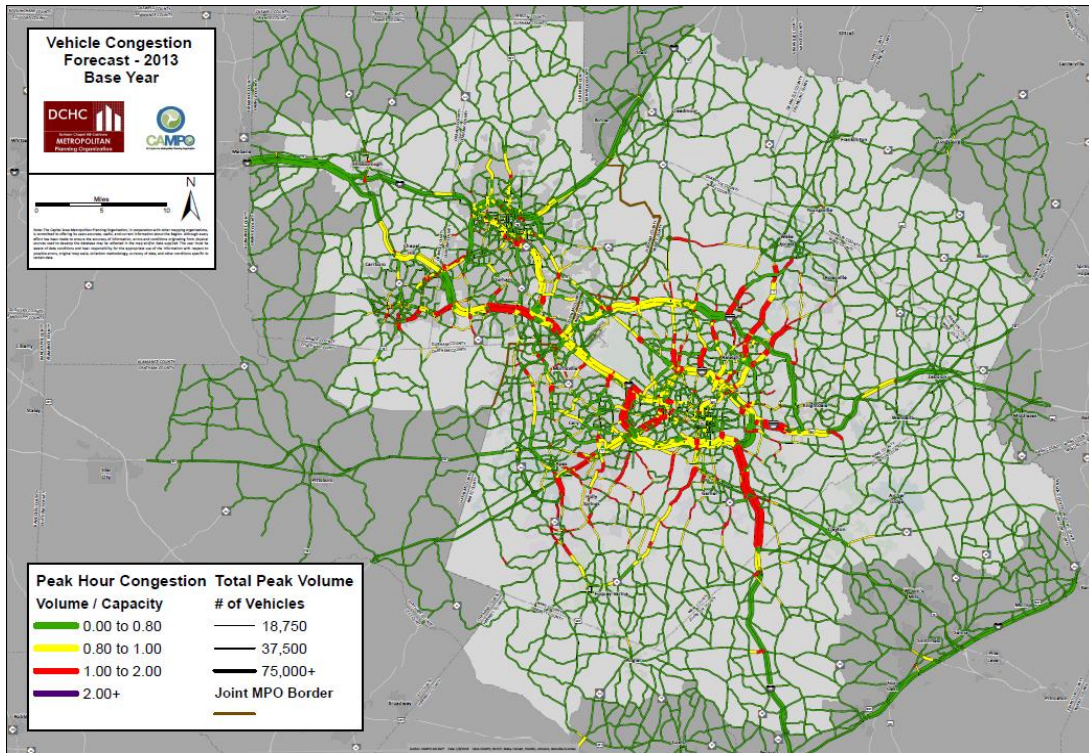

Figure 3-2 Vehicle Congestion Forecast - 2013 Base Year

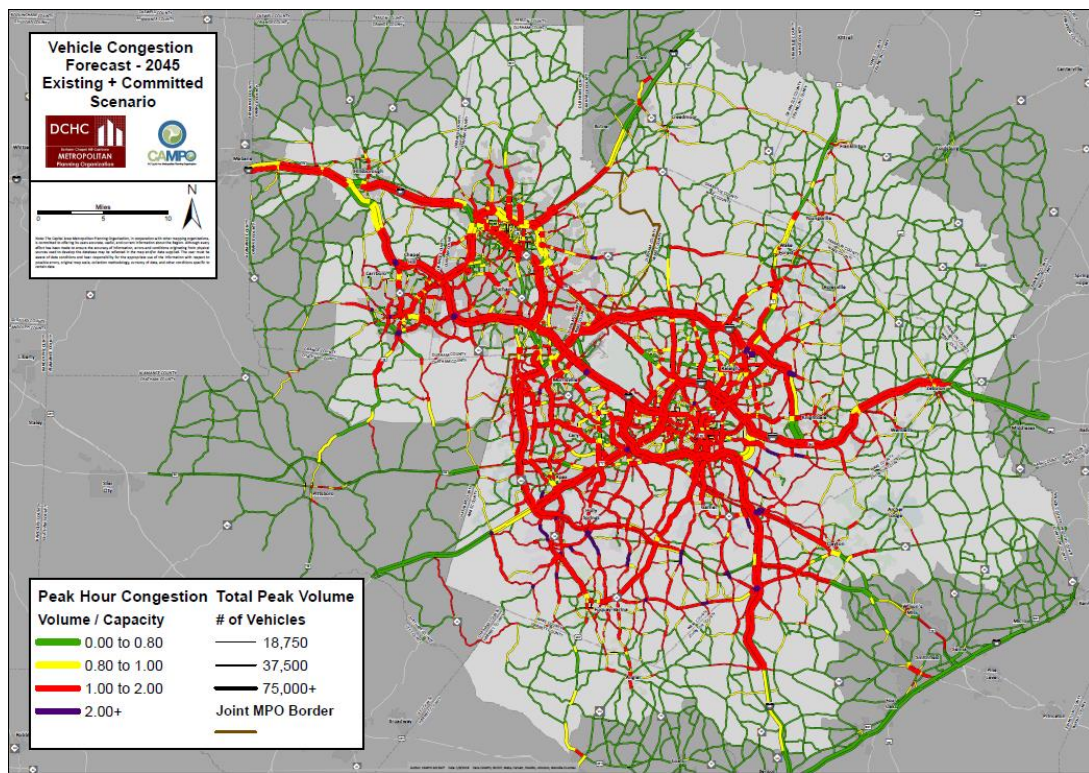

Figure 3-3 Vehicle Congestion Forecast - 2045 Existing + Committed Scenario

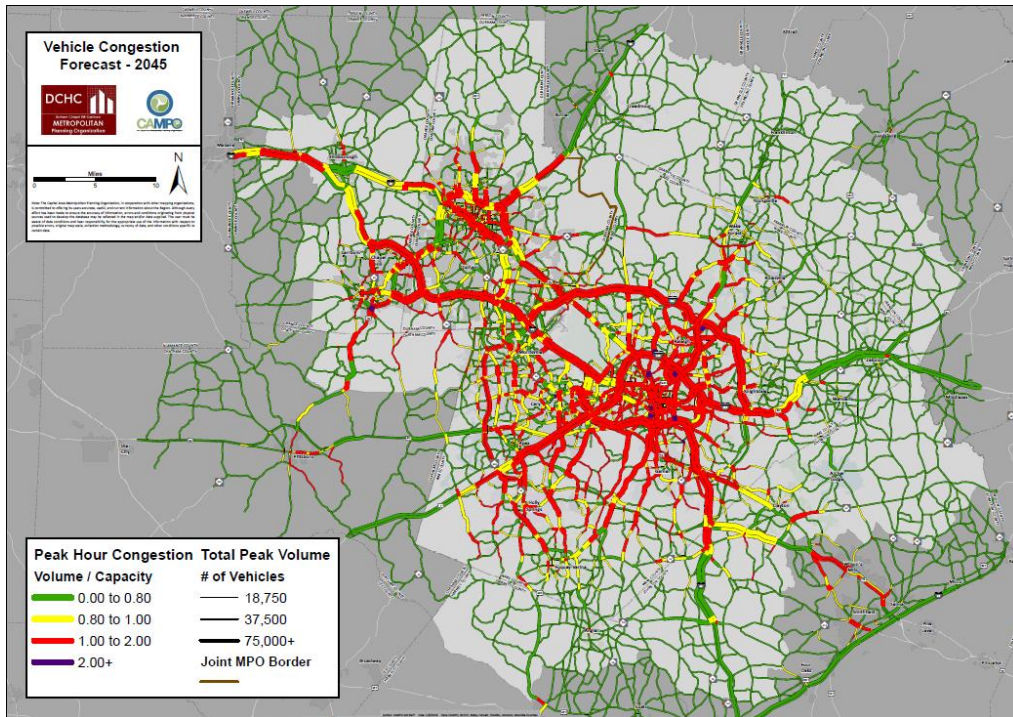

Figure 3-4 Vehicle Congestion Forecast - 2045

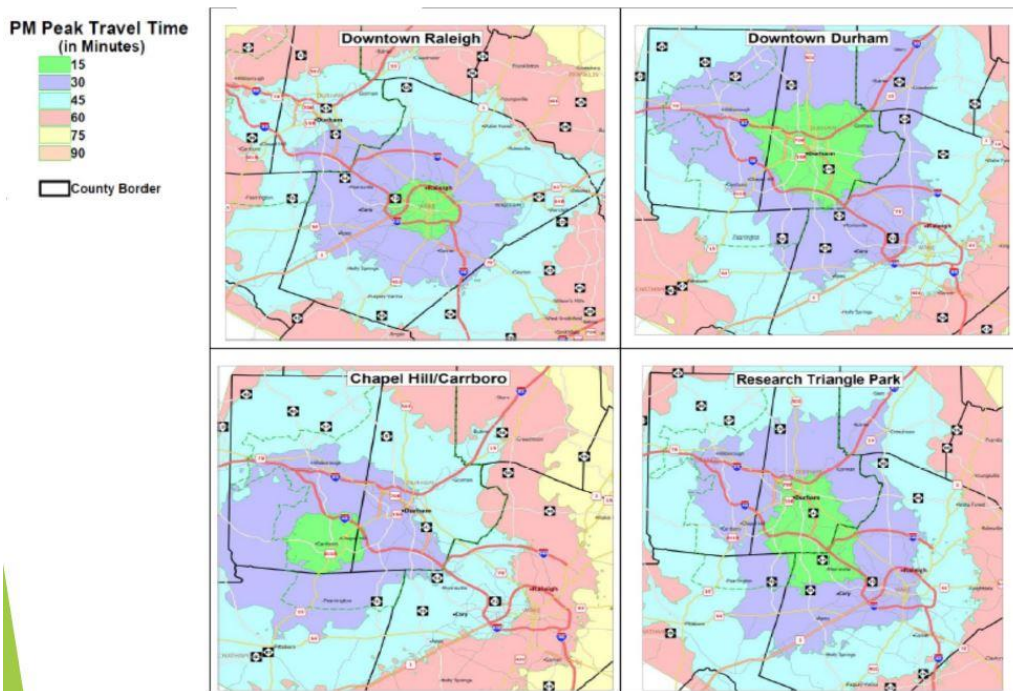

Figure 3-5 2045 PM Peak Travel Times

04 BEST PRACTICES

4 BEST PRACTICES

This section highlights the existing body of knowledge regarding the implementation of toll and managed lane facilities. It seeks to identify, examine, and document relevant issues related to the state of practice for tolling and managed lane strategy development.

4.1 OPERATING POLICY

Implementing additional tolled facilities in the Triangle Region will require an indefinite commitment to actively manage traffic operations to maintain and optimize performance on any new capacity developed. This is especially important for priced managed lane facilities, which introduce an additional layer of complexity due to their proximity to general-purpose lanes, and unfamiliarity in the Triangle Region. While some aspects of operations overlap with the maintenance of the state highway system, the operations of priced managed lanes are more associated with optimizing travel time reliability and travel speed benefits for users while maintaining a high level of vehicle throughput. As such, priced managed lanes require different operating policies and procedures compared to general-purpose lanes. These include toll collection methods, eligibility requirements, operating hours, and pricing plans. Additionally, enforcement of the various operating policies is required. This section describes best practice applications of these concepts for consideration for future priced managed lane concepts in the Triangle Region.

TOLL COLLECTION

New tolled facilities in the Triangle Region will require a clear policy for toll collection agreed upon by project sponsors and stakeholders. As discussed previously, a regional precedent for toll collection has already been established by the NCTA and the *NC Quick Pass* program. Any new tolling initiatives would need to closely consider interoperability with the Triangle Expressway (NC 540) to provide the greatest flexibility and convenience to potential customers. However, as priced managed lanes would be new to the Triangle Region, there are certain unique toll collection aspects that would need to be established during the planning process.

ELECTRONIC TOLLING

Electronic toll collection (ETC) technology has become standard for tolled facilities and priced managed lanes throughout the country, with facilities often replacing its infrastructure every 7 – 10 years, depending upon new technologies. Its application allows for variably priced tolls as a tool to manage highway traffic demand based on time of day and prevailing traffic conditions. The use of ETC on priced managed lanes is essential to address safety issues and avoid the travel delay and congestion associated with manual toll collection at booths or toll plazas. ETC systems utilize automatic vehicle identification (AVI) technology using transponders to detect the unique identification of all vehicles passing toll collection points. License-plate cameras and optical character recognition (OCR) technology have been shown to further enhance the capabilities of capturing toll payments (and violations) from vehicles

using priced managed lanes, as well as enforcement of toll collection when applicable. As the coordinated use of AVI and OCR technology is already in place within the region as part of operations on the Triangle Expressway (NC 540), it may be prudent to maintain this configuration for future tolling projects in the region to maintain consistency in business rules between facilities.

TOLLING MECHANISM

The use of radio frequency identification (RFID) transponders has become the preferred means for tolling and enforcement of priced managed lanes throughout the country. In practice, each transponder is coded with a unique ID number linked to a member agency account, that is debited when a transponder is read at a tolling point. It should be noted that efforts toward national ETC interoperability standards and transponder protocols are currently under development by the International Bridge, Tunnel and Turnpike Association (IBTTA) in accordance with the requirements of the *Moving Ahead for Progress in the 21st Century Act* (MAP-21), which provides Federal funding for surface transportation programs. License plate tolling using OCR technology is also used as a common method of tolling where an image of the license plate is captured and an invoice or violation notice is sent to the registered owner of a vehicle. Recent projects have treated license plate tolling as a secondary means of collection and enforcement, due to the higher cost associated with image processing and verification. As such, a toll premium is typically charged to offset the additional processing costs. This tolling practice is already the regional standard, as established by the Triangle Expressway (NC 540).

Managed lanes provide travel time savings, but these are not often incorporated within contemporary routing programs, such as Google and Waze. As such, it is incumbent upon the operator to make as much data regarding current operations available as possible, through web-based Application Programming Interfaces (API's) to help routing programs leverage the differently operated infrastructure. Additionally, it should be noted that current pricing information has become a key topic within routing systems, with the closest analogue being the General Transit Feed Specification (GTFS) file format for transit routing data. Ultimately, priced managed lanes operators will be responsible for maintaining a live feed of current facility pricing to help travelers make decisions through these mechanisms.

As the feasibility of priced managed lanes is further explored in the Triangle Region, decisions will need to be made regarding policies for the eligibility of HOVs and other vehicle classes to use the lanes. Although these policies would be established later in the planning process, consideration should be given now to vehicle eligibility verification and enforcement. For the enforcement of HOVs, reliance on law enforcement personnel alone is expensive, and automated occupancy verification has not yet proven to be reliable enough for primary enforcement. Enforcement needs to be considered in planning, and advances in technology should be monitored.

- **Lane Based:** On initial express lane implementations, such as SR-91 in Southern California, vehicles that are permitted toll-free access or discounts are physically separated from toll-paying vehicles in toll-zones, creating a “carpool lane” and “toll lane” (Figure 4-1). This method decreases enforcement costs by reducing the total number of users that enforcement personnel

must verify. The separation requires additional right-of-way to accommodate a separated lane, observation location, and enforcement zone (at least 28 feet), that is not always feasible in practice due to physical constraints. Additionally, lane separation may increase weaving ahead of toll zones, leading to increased congestion.



Figure 4-1: Lane Based Declaration

- **Transponder Based:** “Switchable Transponders,” as implemented by NCTA on the I-77 express lanes in Charlotte, provide a technical method for drivers to declare eligibility status. As shown in Figure 4-2, these devices allow drivers to self-declare the vehicle status as SOV, HOV, HOV2 or HOV3+, etc. (depending on local occupancy policies), and will automatically be charged the appropriate toll rate. Under this method, enforcement is focused on verifying the occupancy of vehicles with transponders set to “HOV”, as there is no automated consequence to having an inappropriately identified HOV declaration. If no transponder is present, OCR would be used as a secondary means of enforcement and tolling to ensure full toll payment from the user. Some newer facilities, such as the LBJ Express in Dallas, rely on smart phone applications for carpool registration, essentially serving the same purpose as a RFID transponder. It should be noted that incorrect switch settings are commonplace on active facilities, but incidence is greatly reduced with regular, recurring, and visible police enforcement.

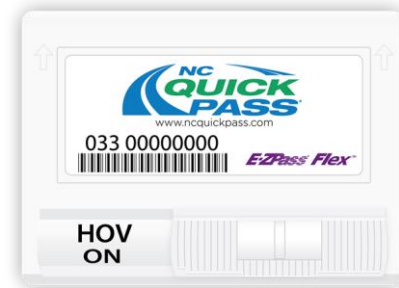

Figure 4-2: NC Quick Pass E-Z Pass

PRICING MODELS

Another important aspect of priced managed lanes to consider during the planning process is the preferred pricing model. Managed lane projects throughout the country have showcased multiple pricing mechanisms, including time-of-day and dynamic pricing, as well as other considerations such as segment pricing, and differentiated payment classes. These different models are summarized below:

- **Time of Day Pricing:** Variable pricing based on a set time schedule is currently used on SR-91 in Southern California and all express lanes in the Denver and Houston areas. Although prices are fixed based on a time-of-day schedule, drivers are charged differently based on direction, day of travel, and hour. This method provides a level of price certainty and predictability for drivers. The most effective applications of this method involve a high degree of variability by time of day and day of the week, and a system for altering toll rates over time. On the SR-91 Express lanes, performance is monitored daily, with evaluation and adjustments to pricing made every three months.
- **Dynamic Pricing:** Variable pricing based on real-time traffic conditions is the most common mechanism used in the United States. This practice is enabled by vehicle detectors that provide a stream of traffic performance data, and tolling algorithms that determine appropriate toll rates based on real-time managed lane and general-purpose lane conditions. This method allows the greatest level of control and flexibility for corridor traffic operations, as the rate can be raised or lowered based on real-time demand to maximize the performance of the lane.
- **Segment Pricing:** Segment pricing sets a specific toll for a specific segment of roadway. Any given toll facility can have one segment, or multiple segments. The segments are usually defined by freeway ingress and egress points, by minimum or maximum distance thresholds, or by spatial relation to an important decision point or common destination. From an operations perspective, segmental pricing allows segments with higher demand to be better managed through higher toll rates. On the I-15 Express lanes in Salt Lake City, segmental pricing has been shown to be easily understood by the public.
- **Minimum and Maximum Tolls:** Dynamically priced express lane facilities often use maximum and minimum toll rates to provide context for system management. The intent is to ensure that some level of revenue is collected during periods of low-demand to defray operational costs (minimum tolls), and that toll rates do not reach a level that can result in negative public perception (maximum tolls). HOT lane facilities can revert to “HOV only” status if overall demand becomes too high. On the I-10 and I-110 Express lanes in Los Angeles, the toll system switches to HOV-only mode once the maximum toll can no longer maintain reasonable operating conditions, until the overall demand is returned to a manageable status. If used, minimum and maximum toll rates should be evaluated and adjusted periodically to account for changes in the ability of the maximum toll to maintain operating conditions as demand grows. For example, if a maximum toll rate is set too low, system performance goals may be degraded.

OCCUPANCY & VEHICLE ELIGIBILITY

Toll projects can introduce an opportunity to establish different payment classes based on overall goals of the facility. On priced managed lanes, applied toll rates can vary for different users depending on policy priorities and the goals of the facility. For instance, toll discounts or exceptions may be made based on vehicle occupancy, vehicle type (e.g., hybrids, Electric Vehicles, etc.), vehicle classification

(e.g., passenger vehicle, truck, etc.), or other criteria. Whatever the priorities of the priced managed lane, protocols for changing or updating these payment classes periodically should be considered. This practice can better enable the facility to meet desired goals and result in better performance over time.

HOV EXEMPTIONS

Although a new concept in the Triangle Region, HOT lanes may prove to be a feasible option, and meet stakeholder goals, as part of a regional tolling strategy. A HOT lane would provide free or discounted access to carpool vehicles (of varying occupancy), while charging single occupancy vehicles (SOV) a toll to utilize the lanes. There are many HOV access policy examples from existing managed lanes facilities. These policies vary based on occupancy, such as whether a vehicle with two or more people (HOV 2) or three or more people (HOV 3) qualifies for access and can also vary on payment class and schedule. Over time, some facilities in Colorado, Florida, and Washington have changed their HOV policies to meet current levels of demand, after significant data review and stakeholder engagement. Several of these options are summarized below:

- **HOV Toll-Free:** Qualifying HOV vehicles are offered free access to priced managed lanes throughout the country, but occupancy policies vary. For example, some facilities such as the I-15 Express lanes in San Diego offer free access to HOV 2 vehicles, while other facilities such as the 95 Express in Miami or the I-85 Express lanes in Atlanta require HOV 3 for free access. Both facilities require HOVs to have transponders, and qualifying carpools in Miami must pre-register. These policy decisions are based on HOV demand, as well as the revenue needs or congestion relief goals of a given facility. This underscores the need to establish priorities and protocols for agencies to adjust HOV occupancy if necessary. As an example, CDOT Express lanes in Colorado were initially implemented with an HOV 2 free access policy. However, growing HOV demand resulted in a change to a HOV 3 free access policy on January 1, 2017.
- **Peak-period HOV:** In several priced managed lane corridors, HOV demand or facility goals have resulted in more complex HOV access policies. Instead of 24-hour toll-free access for HOV 2 or HOV 3 vehicles, some facilities rely on different HOV policies during peak traffic periods. As an example, the I-10 Express lanes in Los Angeles allow free access to HOV 2 vehicles during off-peak periods, but HOV 2 vehicles are charged a toll Monday-Friday between 5-9 AM and 4-7 PM. A similar policy is in place for HOV 3 vehicles on the SR-91 Express lanes in Orange County, California. Although this policy may improve the functionality of the facility during peak-periods, different peak versus non-peak policies can result in driver confusion.

VEHICLE ELIGIBILITY

In addition to HOV access policies, project sponsors may find it viable to explore additional payment classes based on vehicle type. As with other access policies, free-access, discounts, or toll premiums based on vehicle type will depend on performance goals for the facility. They may also consider other economic and environmental priorities at a regional or state level. Some examples for vehicle type payment classes are outlined below.

- **Clean-Air Vehicles:** Several managed lanes throughout the country allow certain energy efficient single occupancy vehicles free or open access to lanes. Examples can include EPA certified hybrids, inherently low-emission electric vehicles (ILEV) or partial zero-emission vehicles (PZEV), or motorcycles. As an example, the State of California has issued a limited number of colored stickers to PZEV or ILEZ drivers to allow free or discounted access to regional express lanes. However, recent projects in Southern California have recommended that free express lane access to energy efficient SOVs be prohibited during peak-periods because of existing facility degradation.
- **Large Trucks:** Depending on regional goals, and the design of the priced managed lane facility, larger trucks, particularly those with more than two axles may be prohibited from using the express lanes. Many facilities prohibit large trucks due to their poor performance compared with light vehicles. The lower acceleration rates of these large vehicles can degrade lane performance, particularly on facilities with only one lane in each direction. However, some express lanes in Colorado, Florida, and Texas have allowed for their use. For example, the US-36 Express lanes in Denver and the LBJ Express lanes in Dallas allow large trucks to use the lanes, but both facilities charge a premium to trucks based on the impact to pavement and traffic performance. The US-36 facility charges an additional \$25.00 to trucks on top of the base toll rate, while the LBJ Express applies a toll rate factor of 3X, 4X, or 5X, depending on size. Other facilities such as the I-70 Express lanes in the mountains of Colorado prohibit large trucks due to pavement and cross section design.
- **Transit Vehicles:** Most existing priced managed lanes allow free access to transit vehicles, such as buses and van pools. In many cases, express bus service is considered an important and essential feature of the express lanes, with transit service fully integrated into facility design and marketing. Transit considerations are discussed further in Section 4.4.

HOURS OF OPERATION

The time periods that a priced managed lane facility operates is another important policy consideration for the development of a regional tolling strategy. Depending on factors such as traffic conditions and performance goals for different corridors, agency priorities, and public perceptions, it may be reasonable for managed lanes to operate 24/7 or just during peak periods. About half of all HOV lanes in the United States operate only during peak-periods. This approach is intended to provide reliability and time savings to carpoolers during the most congested times, while ensuring the lane is not unnecessarily underused at other times. However, the integration of toll paying SOVs into a managed lane can allow a facility to be more fully utilized during expanded periods, ensuring reliability and time savings are maintained outside of traditional peaks.

There are advantages and disadvantages to part-time or full-time managed lane hours of operation. Operating priced managed lanes only in the peak-periods can result in lower operations and maintenance costs, and possibly fewer public challenges since the operation would only be part-time. However, part-time operation can also cause confusion among drivers and limit the ability to

effectively manage demand outside of peak-periods. Full-time 24/7 managed lane operations would result in less confusion among drivers, enable revenue collection throughout the day, and provide an option that could provide a reliable trip time at any time of the day.

Most priced managed lanes in the United States operate full-time. Exceptions include I-680 in the Bay Area of California and SR-167 in Seattle which operate during “daytime” hours (e.g., 5:00 AM to 7:00 PM), and the reversible I-15 and I-25 Express lanes in San Diego and Denver. There are also part-time facilities that use priced shoulder lanes on I-35W in Minneapolis and the I-70 Mountain Corridor in Colorado. The I-77 express lanes in the Charlotte region are operated 24/7.

4.2 PUBLIC OUTREACH

An effective public outreach strategy is an essential component of any tolling or managed lane initiative. When done well, an effective campaign will help develop public awareness of the benefits of pricing, as well as to build public and political support. Without a robust strategy of public outreach and education, a new priced facility may be met with skepticism or challenges from the public or elected officials. This is especially true of priced managed lanes in North Carolina because they will be a new concept for the Triangle. A carefully planned and executed outreach strategy will help agency stakeholders and the public better understand how the facility would work, understand the benefits of the concept and encourage drivers to become customers.

Although public outreach campaigns are commonplace for transportation infrastructure projects and improvements, outreach for priced roadway facilities can require different strategies and a greater scope of agency and public involvement. The element of pricing transforms drivers into paying customers, which changes driver perceptions and expectations. **As such, a multifaceted strategy of public involvement, government relations, media relations, and full-fledged educational outreach is necessary to build consensus and avert public challenges.**

COMMON ISSUES

While becoming more widespread throughout the United States and North Carolina, priced facilities are still a new concept in many metropolitan areas. As these projects are inherently different from more conventional highway improvements, they can cause concerns among drivers unfamiliar with the concept. These concerns are commonly voiced during the development of priced facilities throughout the country. Sponsors of the concept should be aware of these issues to address stakeholder concerns during planning, outreach, and project development. The following issues are likely to be of interest to elected officials, government agencies, and public stakeholders, particularly those drivers likely to be using or impacted by the new facility.

- **Project Goals:** A typical issue of immediate interest is the purpose or goal of the tolled facility. Specifically, what are the advantages of pricing versus more traditional roadway capacity improvements? Best practices from managed lanes projects, such as the MnPass program of

the Minneapolis/St. Paul region and Denver's ExpressToll program, has shown that consistent and succinct messaging of the advantages of pricing is essential to clearly communicate project rationale to a variety of public interests. This is especially important in areas such as the Triangle where priced managed lane concepts may be new or not widely understood.

- **Travel Impacts:** The impact of the new lane(s) on adjacent general-purpose lanes and other routes in the project area is a common concern. Although these impacts will vary depending on the facility, outreach should include findings from other facilities, which show that travel behavior varies from day to day. For example, some regular priced lane users may choose to avoid heavy tolls and use general-purpose lanes on some days. Outreach should include messaging on how tolling offers new travel options, while allowing the entire corridor to function more efficiently.
- **User Fees:** Other common concerns may be related to the fees themselves. Specifically, how much will it cost? How are fees determined and when will they change? The public outreach process allows an opportunity for planners to discuss how fees may be established and describe potential ranges in fees. This input can then be used to help shape and further refine pricing concepts. One important distinction of priced managed lanes is the idea of premium service, where a customer is paying for greater travel time reliability and less congestion compared to general-purpose lanes. This message is an important component in any outreach campaign.
- **Revenue:** Another common concern is the use of toll revenue. To address this issue, best practice shows that greater support is possible when toll revenues are used to support the maintenance and operations of the project itself or other improvements in the priced corridor. As an example, the I-15 Express Lane project in San Diego requires any excess revenue (after covering toll system operating and maintenance costs) to be spent improving transit service. To date, toll revenues have funded nearly \$1 million per year in premium express bus services in the I-15 corridor.
- **Equity:** One of the most common concerns with roadway pricing is that it favors higher income individuals, since paying drivers are given an opportunity to bypass congestion. While usage data of existing managed lane facilities suggests that drivers from all income brackets use the facilities on any given day, managing this perception and communicating the overall benefits of such facilities for all income levels is likely the most important part of any outreach or education effort. Additionally, public sentiment may indicate the need for specific programs geared towards lower income travelers. These strategies are discussed further in Section 4.5.

4.3 DESIGN CONSIDERATIONS

The planning and implementation of priced managed lanes presents unique design considerations compared to more traditional highway infrastructure. Previous managed lane project efforts have shown that the design of individual facilities will vary, depending on existing roadway geometrics and

traffic conditions, as well as local and regional priorities. However, an understanding of general managed lane design guidance and principles is an important consideration for the development of a regional tolling strategy in the Triangle. This section outlines best practices for priced managed lane design so that potential managed lane corridors within the region may avoid inconsistencies and incompatibilities that could impact a regional tolling network. While local conditions will impact facility design, and best practice principles should be considered, the development of individual projects will ultimately be governed by prevailing NCDOT and Federal design standards.

SEPARATION & ACCESS

As priced managed lanes are developed as a premium travel option for toll paying customers or otherwise eligible vehicles, consideration should be given as to how priced lanes are separated from general-purpose lanes in the same corridor, and how customers will access those lanes. Successful priced managed lane projects have deployed different separation and access treatments. This section describes the advantages and disadvantages of these options.

SEPARATION TREATMENTS

Priced managed lanes typically operate at higher speeds than adjacent general-purpose lanes during congested periods, and effective strategies for separating managed lanes from other lanes are important for corridor safety. Positively separated managed lane vehicles may even operate at a higher posted speed (e.g., 75 mph) than general purpose lane vehicles (e.g., 55 mph), as is found on facilities in Texas and Virginia. To accomplish these speed differentials, various types of separation have different impacts on operations and constructability, as well as maintenance, enforcement, and incident management. These factors, and the local context of individual project corridors, will ultimately determine which separation treatment is most appropriate. However, the pros and cons of each method should be considered early in the planning process to understand the impacts of potential design tradeoffs later in project development. Most priced managed lane facilities in the United States use painted buffers or striping, traffic channelizers, concrete barriers, or various combinations as described below:

- **Painted Line/Buffer:** Multiple priced managed lane corridors, including the US-36 Express lanes between Denver and Boulder, use a painted buffer separation indicated by solid double white lines at a four-foot (or sometimes less) spacing. This option is the least expensive in terms of capital and maintenance costs and provides the greatest flexibility for operations and access to emergency vehicles. However, this option is also shown to have the lowest traffic reliability and performance due to friction with general-purpose lanes, and potential turbulence from vehicles illegally crossing the painted lines.



Figure 4-3: Sample Buffer Separation, U.S. 36 Express Lanes, Denver, Colorado.

- **Channelizer/Delineator:** Priced managed lane facilities such as I-95 in Miami, SR-91 in Orange County, California and I-10 in Houston employ traffic channelizers or delineators as a separation method. Channelizers are placed at frequent intervals within a buffer area to create a perceived physical barrier to prevent drivers from exiting or entering the managed lanes at undesigned areas. This configuration reduces the risk of buffer crossings and associated revenue leakage, while also allowing emergency vehicle access. However, this option has the highest ongoing maintenance cost. On the I-95 and SR-91 facilities, illegal buffer crossings and vehicle strikes require 30 to 50 percent of channelizers to be replaced annually.



Figure 4-4: Sample Channelizer Separation with HOV Declaration Zone, SR-91 Express Lanes, Riverside, California

- **Concrete Barrier or Grade Separated:** Some priced managed lane projects use concrete barriers or grade separations to designate priced lanes from general-purpose lanes. This option is usually deployed only on reversible or contra-flow facilities due to the major implication of buffer crossings. The I-25 Express lanes in Denver are an example of this strategy. Barrier or grade separation may also be part of large-scale corridor reconstruction efforts such as the LBJ Express in Dallas. Operationally, this option allows for the highest speed differential from general-purpose lanes, prevents buffer crossings and revenue leakage, and has relatively low maintenance costs. However, this option is also the most expensive due to capital and right-of-way costs. Access and egress is also more complicated. This option can also complicate incident management and allows little flexibility for future operational changes.



Figure 4-5: Sample Barrier Separation, I-30 Express Lanes, Dallas, Texas

ACCESS TREATMENTS

The development of a regional tolling strategy should also consider appropriate methods for drivers to access and egress priced managed lanes. Existing priced managed lane facilities provide several examples of regulating entry and exit, which are related in part to the planned separation treatment for the facility. The two major types of express lane access treatments are limited access, which regulate where vehicles may enter and exit the facility, and continuous access, which allows customers to enter and exit the facility at any point. The pros and cons of two limited access options and continuous access are described below.

- **Direct Connector (Limited Access):** Direct connector ramps provide direct access to managed lanes via median drop ramps from freeway overpasses. Direct connectors provide greater efficiency, safety and capacity, while greatly reducing the operational impacts of weaving and merging movements. However, direct connector ramps have high capital costs, significant right-of-way impacts, and can require accommodation on arterial overpasses. Best practices suggest they should only be considered where there is substantial general-purpose lane congestion that would complicate weaving or a significant amount of local demand for access to or from the managed lanes.

- **At-Grade Weave (Limited Access):** Most existing priced managed lane facilities use at-grade access and egress treatments. In this approach, access points represent breaks in designated locations within physical barrier or striped separations. The design of these at-grade weaves is normally accommodated through striping, and there are multiple configurations currently used such as a striped single-line, striped transition or weave lane, or slip ramps. The Manual on Uniform Traffic Control Devices (MUTCD) provides guidance for these types of access/egress points. At-grade access and egress points reduce toll evasion and provides additional access control at a relatively low cost. However, the dedicated locations do result in a concentrated area of weaving that can result in traffic conflicts. They also require adequate enforcement resources to reduce access violations.

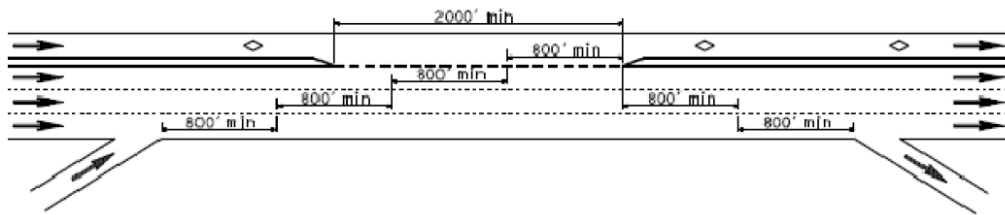

Figure 4-6: Weave-Zone Access Design

- **Continuous Access:** Continuous access allows drivers to enter the priced managed lane facility at nearly any point, with separation from general-purpose lanes normally provided by a single striped or solid line. With continuous access, there are no designated access or egress locations, which results in potentially lower cost, reduced weave concentrations, and greater operational flexibility. However, this method also has the highest potential for toll violations and revenue leakage and requires significant enforcement resources.



Source: Minnesota Department of Transportation

Figure 4-7: Continuous Access on I-35W

SIGNAGE

Priced managed lanes include many unique aspects such as entry and exit locations, occupancy requirements, operating hours, costs and violations that are essential to clearly communicate to users and future users of the facility. Accurate and informative signage is necessary to ensure that operational procedures are easily understood and to enable efficient and productive use of the priced facility. Effective signage provides drivers with adequate time and information to decide to use the managed lane facility, and how to access it safely. The MUTCD provides guidance on signage for managed lanes of all types, and FHWA is completing review of a report for signage on managed lanes networks.

ACCESS & EGRESS SIGNAGE

Adequate signage is critical to direct drivers to access and egress points for the managed lane facility. Signage for the start of a managed lane facility and entrance points should include a combination of advance overhead advance overhead signs and Variable Message Signs (VMS) to let drivers know that they are approaching a managed lane entrance. Signage should also provide information on the price to travel in the managed lane, transponder requirements, and HOV and vehicle eligibility. In addition, static signage is necessary to inform drivers of upcoming managed lane exits, as well as local freeway exits if applicable. Example entrance signage is shown in Figure 4-8.



Figure 4-8: Express Lane Entrance Signage

VARIABLE MESSAGE SIGNS

The current pricing level to access and use the managed lanes is one of the most important pieces of information to share with drivers and potential customers. Nearly all existing priced managed lanes use overhead pricing signs to display the toll amount to a given downstream location, and to convey HOV requirements and discounts, if applicable. Variable message elements can be used to indicate variable or dynamic toll rates. Typically, VMS signs used to display toll pricing information are either a combination of static signs with VMS insets or full matrix VMS (Figure 4-9). Each sign type provides toll rates for downstream destinations and have various advantages and disadvantages. Static signs are generally less expensive and can be more readable. Fully changeable VMS signs provide messaging flexibility but can be less readable and costlier to deploy.



Figure 4-9: Variable Message Signage

TOLL COLLECTION ZONE

As described previously, contemporary tolling systems and priced managed lanes rely on ETC and RFID technology to allow tolling at freeway speeds. Traditional toll plazas are not used in managed lanes. As such, any future priced managed lane in the Triangle will need to incorporate toll zone considerations into the facility design. Toll collection zones include lane controllers, antennas to communicate with transponders, automatic vehicle classification systems for identifying vehicle types, video enforcement systems (VES) for imaging and reading license plates, and other ITS devices such as closed circuit television cameras (CCTV), and vehicle detectors. The ETC and ITS equipment is essential for the toll collection zone to properly detect passing vehicles, read transponders, collect traffic volumes, capture vehicle images, and transmit all information from the roadside equipment to the back office for processing.

ENFORCEMENT CONSIDERATIONS

Enforcement is an important element to consider as part of a regional tolling strategy. On priced managed lanes, enforcement systems are necessary to mitigate violations and reduce revenue leakage, and to facilitate secondary license plate tolling, if applicable. Video enforcement systems and manual enforcement areas should be considered early in the planning process for any priced facility.

- **Video Enforcement System:** Any effective ETC system should include roadside VES elements, such as cameras and lighting mounted on overhead structures, as well as colored LED enforcement beacons to aid enforcement personnel. An example of a managed lane toll zone with these elements is shown in Figure 4-10. During operation of most typical systems, an image is captured of every vehicle's rear license plate as it traverses the toll zone. If a valid transponder is not detected, LPR software reads the vehicle's license plate and matches information to a customer database. If there is a positive match, a toll is charged to the account. If no match is made, the image and associated time stamp is stored and sent to the back office for license plate toll or violation processing.

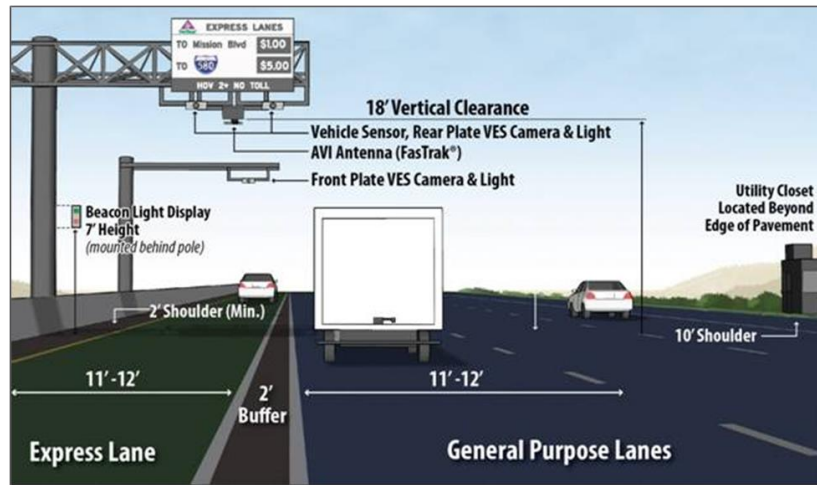

Figure 4-10: Typical Toll Zone Design

- **Enforcement Observation Areas (EOA):** Current technologies for vehicle occupancy detection have not yet proven to be reliable enough for automated vehicle occupancy enforcement. Manual enforcement of HOV occupancy is still standard on contemporary managed lane facilities. Priced managed lane facilities should include locations from which enforcement officers can monitor traffic and identify unauthorized vehicles. The areas should be wide enough to accommodate safety enforcement action and located near tolling points, allowing officers to monitor traffic and enforcement beacons and provide a visual deterrent to potential violators (Figure 4-11). Ongoing costs for police enforcement typically range between \$200,000 and \$1,000,000 annually with costs offset from fees associated with violations.



Figure 4-11: I-45 Enforcement Area, Houston

4.4 TRANSIT

TRANSIT INTEGRATION

Existing priced managed lanes have shown that they create a valuable opportunity for transit agencies to expand express bus service and enhance regional transit options. When managed through variable pricing to maintain a minimum level of service, managed lanes create efficient and reliable transit corridors from previously congested freeways. Operating express bus service on priced managed lanes has demonstrated several key benefits to transit services including:

- Shorter travel times and greater reliability by maintaining reasonable travel speeds and avoiding unpredictable congestion
- Lower operating costs due to improved travel time and reliability and less schedule uncertainty
- Increased transit ridership due to improved reliability
- Potential new revenue sources from toll revenues
- Broader public support and fewer equity concerns by enhancing transportation options and mitigating negative public perceptions

For these reasons, many transit agencies have introduced express bus service on managed lanes, albeit few have used the opportunity to implement in-line stations for Bus Rapid Transit (BRT) deployment.



Figure 4-12: In-line BRT station on I-35W Express Lanes, Minneapolis, Minnesota

Multiple managed lane initiatives have also considered transit to be an essential component of priced facilities and have included transit at the forefront of all marketing and messaging efforts. The performance of managed lane transit service is dependent on design and policy factors, which should be considered early in the planning process. This section provides an overview of three successful transit operations on priced managed lanes, and summarizes lessons learned from these services.

CASE STUDIES

To better understand how transit agencies have integrated bus service into express lanes, three cases are presented in this section: Los Angeles Express Lanes, Miami 95 Express, and San Diego I-15 Express lanes.

- **Los Angeles Express Lanes:** Transit has been considered a key component of the I-110 and I-10 Express lanes in Los Angeles since the beginning of the planning process, when one of the major project goals was to move more people, not more vehicles. The Los Angeles Express lanes opened in November 2012. As of June 2014, the combined annual transit ridership on the I-110 and I-10 Express lanes exceeded 15 million riders per year. In addition to converting existing carpool lanes to express lanes, LA Metro used a sizable portion of a \$210 million Urban Partnership Agreement/Congestion Reduction Demonstration (UPA/CRD) grant from USDOT to expand transit services on those lanes. Transit enhancements included improved headways, new routes, new vehicles, and station infrastructure (including park and ride facilities and direct access ramps for buses). As an example, implementation of the 26-mile LA Metro Silver line along I-110 increased ridership 103 percent with 5-minute headways during peak periods.
- **Miami 95 Express:** Miami also received federal funding through the UPA/CRD Program to alleviate traffic congestion on the I-95 corridor through the implementation of priced managed lanes. The project replaced the existing single HOV lane in each direction with dual HOT lanes. The HOV occupancy requirement was also increased from HOV 2 to HOV 3. Transit improvements included enhancements of existing routes, new express routes, increased park-and-ride lot capacity, and arterial signal coordination. Following implementation, average bus travel times decreased from 25 minutes to 8 minutes, and average speeds increased from 18 mph to 57 mph. Weekday ridership on the 95 Express lanes increased 57 percent. Based on passenger survey results, 53 percent of new riders stated that the opening of the express lanes influenced their decision to use transit. Of the new riders, 45 percent previously used another form of transit, and 38 percent used to drive alone.
- **San Diego: I-15 Express Lanes:** In 2012, a \$1.4 billion expansion of I-15 was completed, including replacement of the prior dual lane reversible priced managed lanes with a four-lane facility featuring a moveable median barrier. The project also included enhancements to the Rapid Express bus service, such as the completion of direct access ramps from the managed lanes to transit park-and-ride facilities along the 20-mile corridor between Escondido and San Diego. Direct access ramps connect park-and-ride lots and transit stations with the managed lanes, which allows buses to enter the lanes without crossing the general-purpose lanes. Rapid

Express bus service improvements included transit signal priority, real time arrival signage, enhanced passenger shelters, fewer stops, and 29 new express buses.

LESSONS LEARNED

The review of existing priced managed lane facilities with successful transit services provides a valuable set of lessons learned from both physical and policy perspectives. Managed lane facilities must be designed to efficiently move buses to integrate transit successfully. There are also numerous policy considerations that can influence transit success along a corridor.

DESIGN CONSIDERATIONS

Based on the characteristics of existing managed lane facilities that have successfully integrated transit, the following considerations should be considered in the planning and design of transit service on express lanes²:

- **Maintain Level of Service:** Toll pricing levels should be managed to maintain a minimum level of service (LOS) for transit vehicles. If minimum speeds and LOS are maintained on priced managed lanes through variable or dynamic pricing, transit services have witnessed benefits from travel time reliability, improved headways, and associated ridership increases.
- **Direct Access Ramps:** Priced managed lanes should be designed where possible with direct access ramps for transit vehicles. Direct access and egress locations avoids vehicles having to cross multiple general-purpose lanes to access the managed lanes, which is particularly challenging for large buses. Shoulder-running express lanes also provide flexibility for access and egress locations.
- **Park-and-Ride Lots:** Effective managed lane transit services should integrate park-and-ride lots close to the facility. In several cases, toll revenue has been used to fund construction of new park-and-ride lots, expanding transit access. In an ideal situation, park-and-ride lots would be located directly adjacent to the managed lanes, with access provided by direct access ramps.

² Newmark, 2014

- **Station Facilities:** The most effective managed lane transit services include transit stations along the facility, which directly interface with the managed lane. These stations are either “In-line,” which are within the footprint of the managed facility, or “Off-line,” facilities that are located near the managed lanes, but not directly within the roadway footprint. In-line stations, such as those deployed on the I-110 Express lanes in Los Angeles (Figure 4-13), are intended to serve pedestrian passengers, bicycle riders, and feeder transit lines. Benefits include less right of way, less ramp construction, and time savings for passengers. Drawbacks include longer walking distances and expensive handicap access. Off-line stations are often located at park-and-ride lots, large employment centers, or major transit centers close to the managed lanes corridor. These stations might require a direct connector ramp to be most effective and can also result in somewhat longer total travel times for passengers. However, they can also facilitate easier pedestrian access and parking.

POLICY CONSIDERATIONS

Each priced managed lane project has unique policies in place that influence how well transit is integrated in a particular corridor. The most successful facilities for enhancing transit service consider transit an integral part of the facility and may establish revenue sharing policies to facilitate transit operation. Establishing a set of policies that improves transit service and capacity is often essential in building public support for often controversial toll lane projects and helps to neutralize the concept of “Lexus Lanes.” The following key policy considerations relate to transit integration into priced managed lanes³:

- **Dissuade Shifts to Driving:** One potential consequence of priced managed lanes is that some existing transit riders on the facility may start to pay to drive alone. To address this, some agencies have instituted minimum toll rates that are at least as high as transit fares, so there are not price advantages for solo driving. In Los Angeles, tolls in the morning and afternoon peak periods for the full trip on the Express lanes must be at least 1.5 times the Metro Bus Rapid Transit fare of \$2.45.
- **Transit Outreach:** As priced managed lanes are still a relatively new concept and require a broad public outreach campaign, there is an opportunity to highlight transit improvements as part of the project. As an example, the US-36 Express lanes in Denver



Figure 4-13: In-Line Station on I-110

³ Newmark, 2014

advertised the transit improvements at the forefront of the project outreach effort. This approach underscores that managed lane projects can benefit multiple modes.

- **Revenue Transfer:** One of the most critical considerations for successful managed lane transit integration is the distribution of toll revenue. Several priced managed lane facilities have established policies that dictate how toll revenue remaining after toll system operations and maintenance is distributed. The I-10/I-110 Express lanes in Los Angeles, 95 Express in Miami, and I-15 Express lanes in San Diego all receive toll revenue to support existing transit services and potential improvements.
- **Interoperable Fare System:** Toll system interoperability between different tolling facilities is becoming increasingly commonplace. To establish a transit rewards program, tolling accounts must be linked, or better yet, interoperable with transit accounts. If multiple agencies are involved in the operations of the toll lanes and transit service, this will require close interagency coordination. The LA Metro Express Lanes Transit Rewards program serves as a best practice example, where toll credits can be earned on 10 express bus routes throughout Los Angeles County.

At some point, tolling approaches and the Wake Transit Plan will be required to be integrated in a coordinated manner.

4.5 EQUITY CONSIDERATIONS

As interest in roadway pricing has grown, and more priced managed lane facilities have been developed, the concern that pricing proposals may be unfair to some drivers or population groups has also grown. A key reason for public reluctance toward acceptance of roadway pricing can be the failure to address equity concerns adequately. Despite the many social and economic benefits of road pricing, educating the public of the value of tolling requires a careful analysis of the distribution of costs and benefits across different socioeconomic groups, especially where the impacts may be felt by a large and diverse number of people. Many congestion pricing proposals have encountered substantial public resistance and even intense opposition.

Tolling opponents have raised objections including: (1) drivers are paying for what has traditionally been “free”; (2) drivers are paying twice for same facilities (gasoline taxes plus tolls); and (3) there are disproportionate distributions of costs/benefits. A successful tolling strategy for the Triangle should include an open, transparent, and inclusive process for evaluating potential social equity and environmental justice (EJ) concerns that may arise as part of the development of a regional tolling network. This section outlines best practice considerations for an equity analysis and framework process and highlights mitigation strategies that have been included in successful priced managed lane facilities.

EQUITY ANALYSIS & FRAMEWORK

The main purpose of an equity analysis should be to understand how a tolling or a priced managed lane strategy will affect specific EJ communities and how it can be made fairer for all. The analysis should consider both short term and long term impacts and build in flexibility to respond if conditions change. As described in Section 4.2, project experience has shown that public engagement is crucial in addressing concerns about and building public support for tolling initiatives. Agency and public stakeholders should be engaged in a process that provides meaningful public dialogue about the proposed tolling strategy, how it will be financed, how the revenues will be collected and spent, what the equity impacts may be, and how any negative consequences can be minimized and mitigated. The direct costs of a tolling project will be borne primarily by those who pay tolls to access the facility. The focus of the equity assessment should be to determine whether these costs fall disproportionately on certain groups, and if that is reasonable when considering the ability to pay, benefits received, or costs imposed. Some equity issues that should be considered while undertaking an EJ analysis for priced managed lanes include:

- **Income Equity:** Depending on the financing plan, some individuals could pay gasoline or sales taxes and the revenue collected is spent to fund managed lanes that they will not use, rather than some other services. The equity evaluation should consider how sources of funding may impact different groups and whether any imbalance can be mitigated by changing the way that any revenues from tolling are spent.
- **Modal Equity:** The equity evaluation should also consider the distribution of indirect costs and other non-economic factors, like whether general-purpose lane users would experience more traffic congestion, and which groups change their travel modes or trip-making behavior.
- **Geographic Equity:** Noise, air quality, and traffic impacts on local communities and neighborhoods should also be evaluated. Additional long-term potential impacts could include changes in land use patterns that might take place due to changes in accessibility or local traffic patterns affecting residents and businesses in low-income or disadvantaged areas.

MITIGATION STRATEGIES

Although priced managed lane initiatives can face equity challenges, it is important to note that all income groups can benefit from the implementation of pricing. Freeway users, even low-income users, may benefit indirectly from additional road capacity because toll paying drivers will not be competing for space on existing general-purpose lanes. In addition, a survey of drivers on the 91 Express lanes in Orange County found that households earning below \$50,000 annually used the lanes about as often as those earning \$200,000 or more. Another study showed that 19 percent of peak period users had

household incomes below \$40,000 and only 21 percent above \$100,000⁴. A study of the I-15 express lanes in San Diego found strong support among all income levels⁵.

One of the most frequent criticisms of priced managed lanes is that they primarily benefit high-income drivers who can afford to pay a toll for premium travel, while low-income drivers are forced onto more congested general-purpose lanes. The impression that express lanes are just “Lexus lanes” is a powerful impediment to achieving public acceptance for priced lanes. To mitigate these concerns, several priced managed lane projects have included policies of targeted revenue allocation, discounts for low-income drivers, and opportunities to earn toll credits by traveling on other modes. Four case studies are described below.

I-15 FASTRAK FUNDING OF INLAND BREEZE EXPRESS BUS SERVICE

The San Diego Association of Governments (SANDAG) used toll revenues from the I-15 express lanes to fund a new express bus service called Inland Breeze. Most Inland Breeze passengers were dependent on public transit for their travel, increasing mobility options for lower-income corridor residents. The new toll-financed express route was quite effective in attracting ridership, but did not meet expected goals.

I-95 EXPRESS LANE FINANCING OF EXPRESS BUS SERVICES

In 2008, FDOT used federal funding to convert I-95 HOV lanes into HOT lanes in Southeast Florida. As a condition of the federal funding, new I-95 express bus service was implemented. As usage of the I-95 toll lanes increased, toll funding became available to maintain the initial express bus expansion plus finance substantial growth in transit services. Toll revenues currently fund all operating and maintenance costs for I-95 bus services. I-95 Express Bus Service grew from three routes and 1000 weekday trips in 2010 to nine routes and 3500 weekday riders by 2015.

LA METRO EXPRESS LANES ON I-10 AND I-110

LA Metro has implemented one of the most comprehensive equity programs in the United States. It includes the following elements:

- **Revenue Allocation:** The LA Metro revenue policy is that all gross toll revenues from the Express lanes are first used to pay for their maintenance, administration, and operation. All remaining revenue that is produced must be used in the respective corridor from which it was collected. Revenue allocation guidelines include enhanced transit service to address equity concerns.
- **Discounts:** LA Metro offers low-income residents of Los Angeles County a per-household account set-up fee waiver equal to the cost of the required transponder (\$25) for accounts

⁴ Sullivan, 2000

⁵ Zmud and Arce, 2008

related to the I-110/I-10 Express lanes. Eligible participants must be Los Angeles County residents, and meet low-income thresholds that are double the current Federal poverty level.

- **Toll Credits:** LA Metro has addressed the needs of transit riders along the two toll corridors by offering frequent transit riders (many of whom are low-income) a \$5 per month toll credit for using certain routes more than 16 times each month.
- **Carpool Loyalty:** LA Metro also operates a carpool loyalty sweepstakes. As part of the program, FasTrak account holders enter a monthly drawing every time that they use the Express lanes with their transponder set to HOV mode. The monthly drawing awards winners with toll credits and gift cards.

ATLANTA'S I-85 RIDE TRANSIT-EARN TOLL CREDITS PILOT PROGRAM

The Georgia Regional Transportation Authority (GRTA) implemented a six-month pilot program to reward frequent transit users with toll credits. The program's objective was to save users of selected *Xpress* and Gwinnett County Express routes time and money on those days when they must use the I-85 Express lanes. Program participants could earn a toll credit of \$2.00 per trip, up to \$10.00 per month with a maximum benefit of \$60.00 for the six-month trial period. Participants had to have a *Peach Pass* transponder tied to a personal toll account and the applicable transit pass (*Xpress* or MARTA *Breeze* card).

05 RESULTS OF ANALYSES

5 RESULTS OF ANALYSES

This chapter contains two sections. The first section summarizes the results of the Tier 1 screening analysis and identifies the corridors and corridor segments which advanced to Tier 2 of the study. The second section of this chapter describes the results of the more detailed analysis for those roadways carried over into the study's second tier.

5.1 TIER 1 SCREENING

INITIAL SCREENING

The Triangle Regional Model (TRM) was used to estimate PM peak volumes for the following three scenarios:

- 2013 Base Year
- 2045 Existing and Committed improvements
- 2045 Metropolitan Transportation Plan (MTP) improvements under the Moderate scenario (projects funded without financing from innovative or add-on sources)

The PM peak was selected for screening because this period represents the worst-case (greatest congestion) scenario.

Two screening criteria were used to identify candidate corridors:

- 1 Congestion
 - Congested: Volume/Capacity (V/C) ratio 1.1 and over
 - Near Congested: V/C ratio between 0.9 and 1.1
 - Not Congested: V/C ratio less than 0.9

- 2 Speed Reduction (the difference between free flow and congested speed)
 - Over 40 percent
 - 40 percent to 30 percent
 - 30 percent to 20 percent
 - Less than 20 percent

Figure 5-1 shows Triangle congestion after MTP project implementation while Figure 5-2 indicates speed reduction after the MTP.

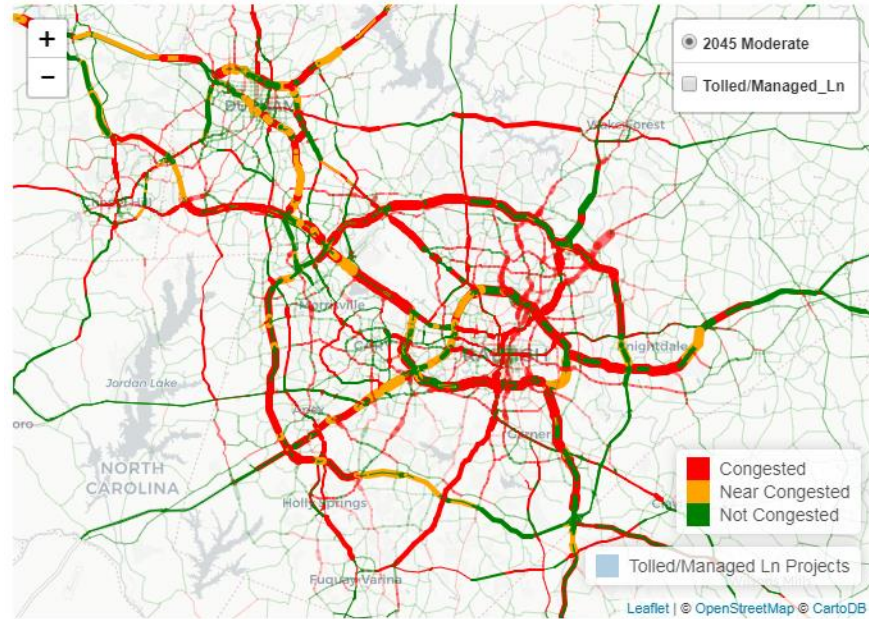

Figure 5-1 Congestion Map with MTP Projects

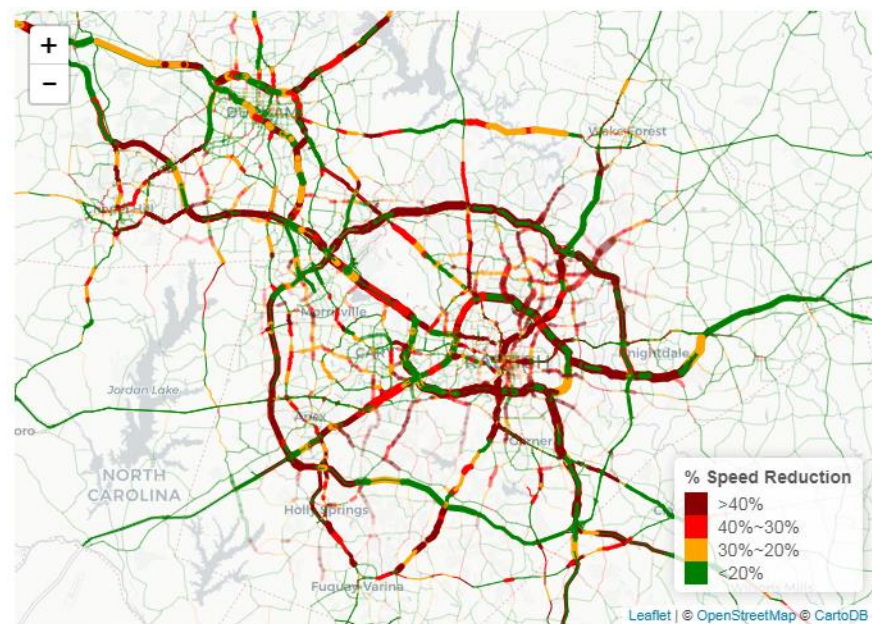

Figure 5-2 Speed Reduction with MTP Projects

After noting that the Triangle Region would be experiencing severe congestion following MTP implementation, existing critical corridors were identified using real time traffic data from Google Maps. Figure 5-3 shows travel speeds on a typical Wednesday afternoon at 5:30 PM (PM peak).

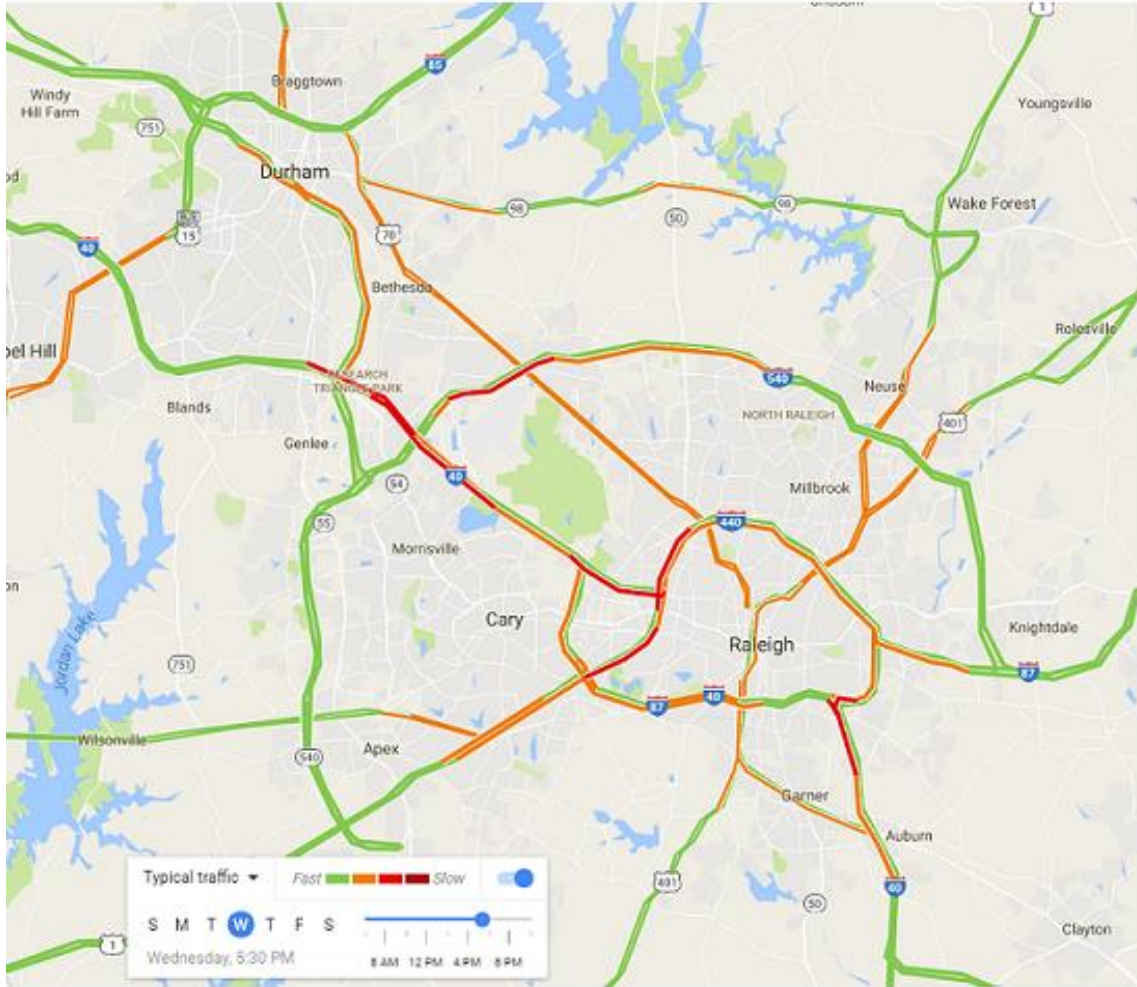

Figure 5-3 Critical Corridors Using Real Time Data

The next step in the screening process involved overlaying MTP projects on current and future congestion maps. Figure 5-4 illustrates current congestion and MTP projects, including toll, managed lanes and widening projects. This approach identified projects targeted for widening, but not identified as managed lanes projects. Figure 5-5 is an overlay of just toll and managed lanes projects on the current congested map. A comparison of Figure 5-4 and Figure 5-5 showed system gaps based on screening criteria and experience. Figure 5-6 is a map of the corridors recommended for further screening.

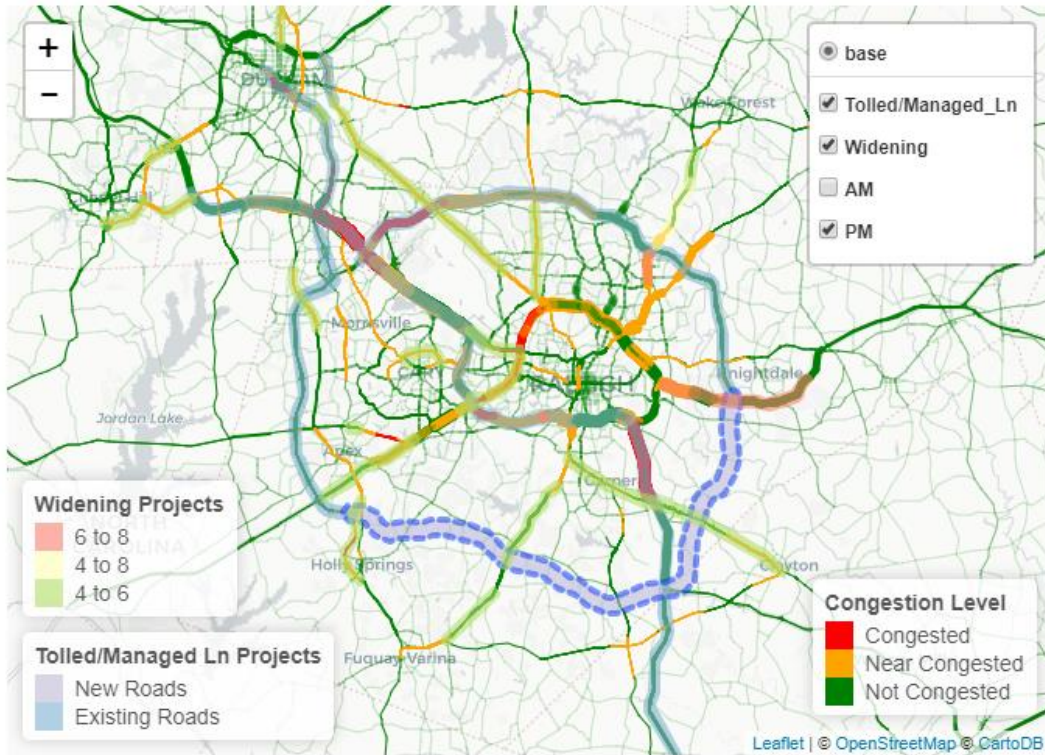

Figure 5-4 Current Congestion and MTP Projects

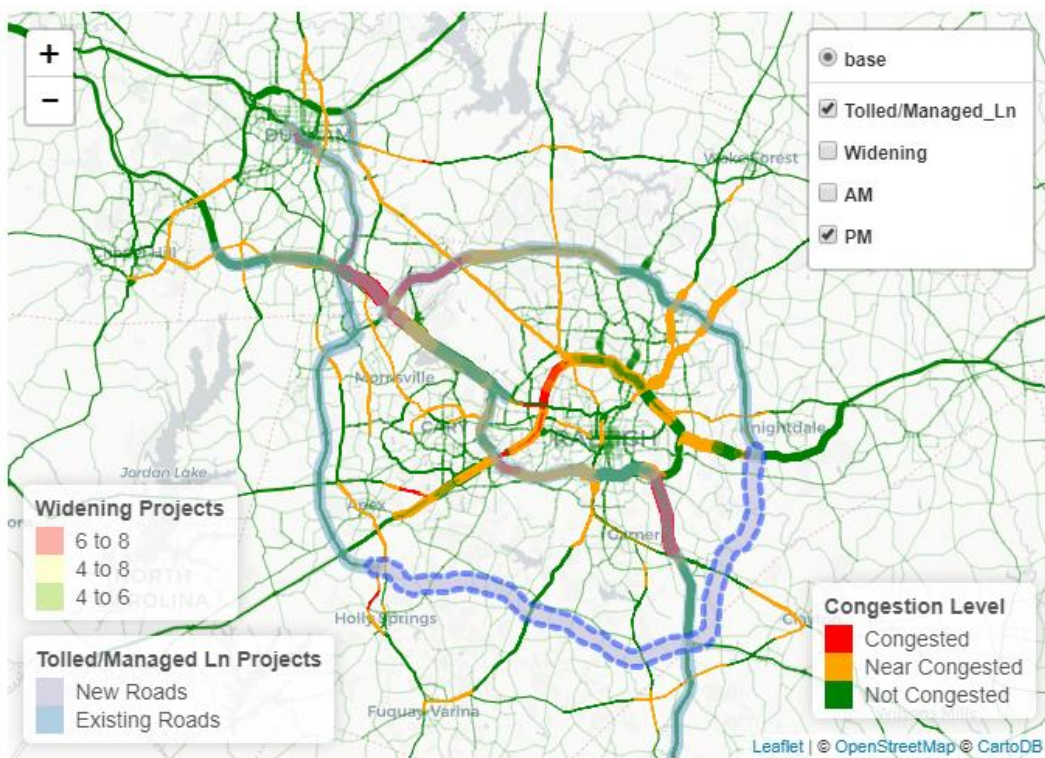

Figure 5-5 Current Congestion and MTP Tollo and Managed Lanes Projects Only

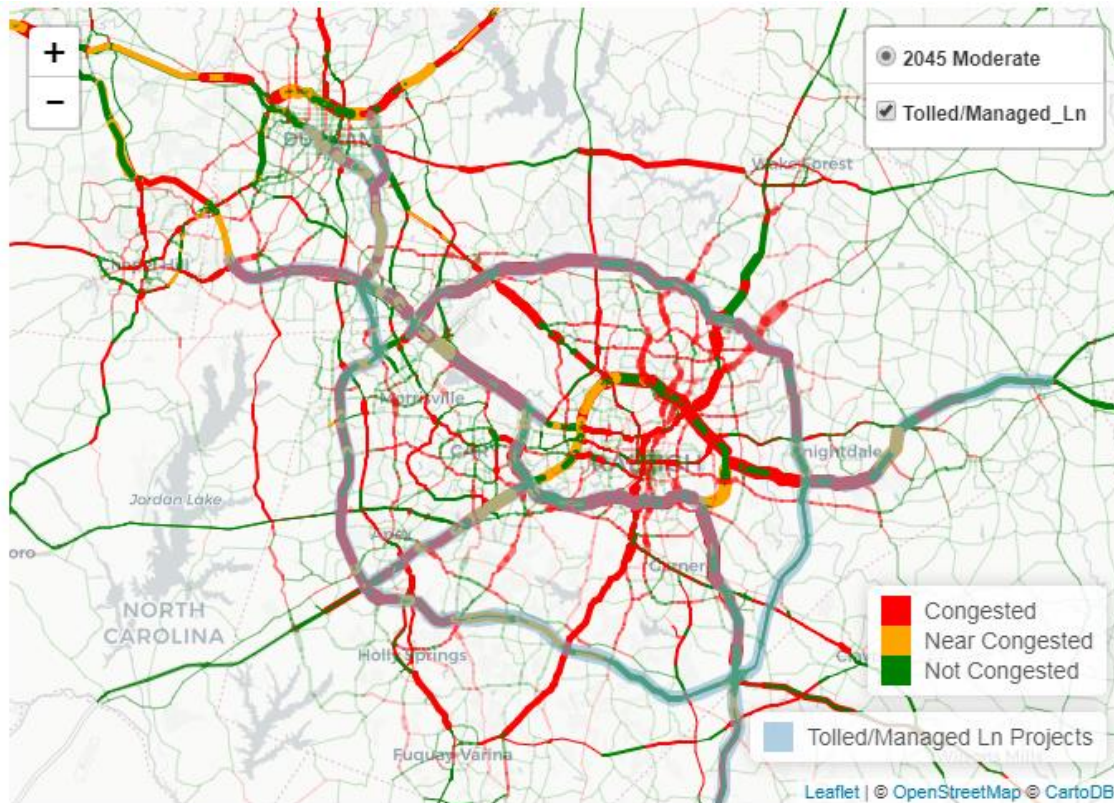

Figure 5-6 Projects Recommended for Further Screening

SECOND ROUND OF SCREENING

On May 17, 2018, the Core Technical Team (CTT) reviewed the candidate corridors from initial screening. The group proposed changes to the preliminary system using the following guidelines:

- Include facilities that are currently freeways or proposed to be freeways by 2045
- Include facilities which are forecasted to be congested in 2045

The updated corridor map based on CTT comments is shown in Figure 5-7. This system of express lanes was used for additional TRM analysis using the following parameters and assumptions:

- 2045 scenario including all MTP projects
- Existing managed lanes changed to General Purpose lanes
- General Purpose lane added in each direction for corridors without managed lanes in MTP
- One managed lane in each direction

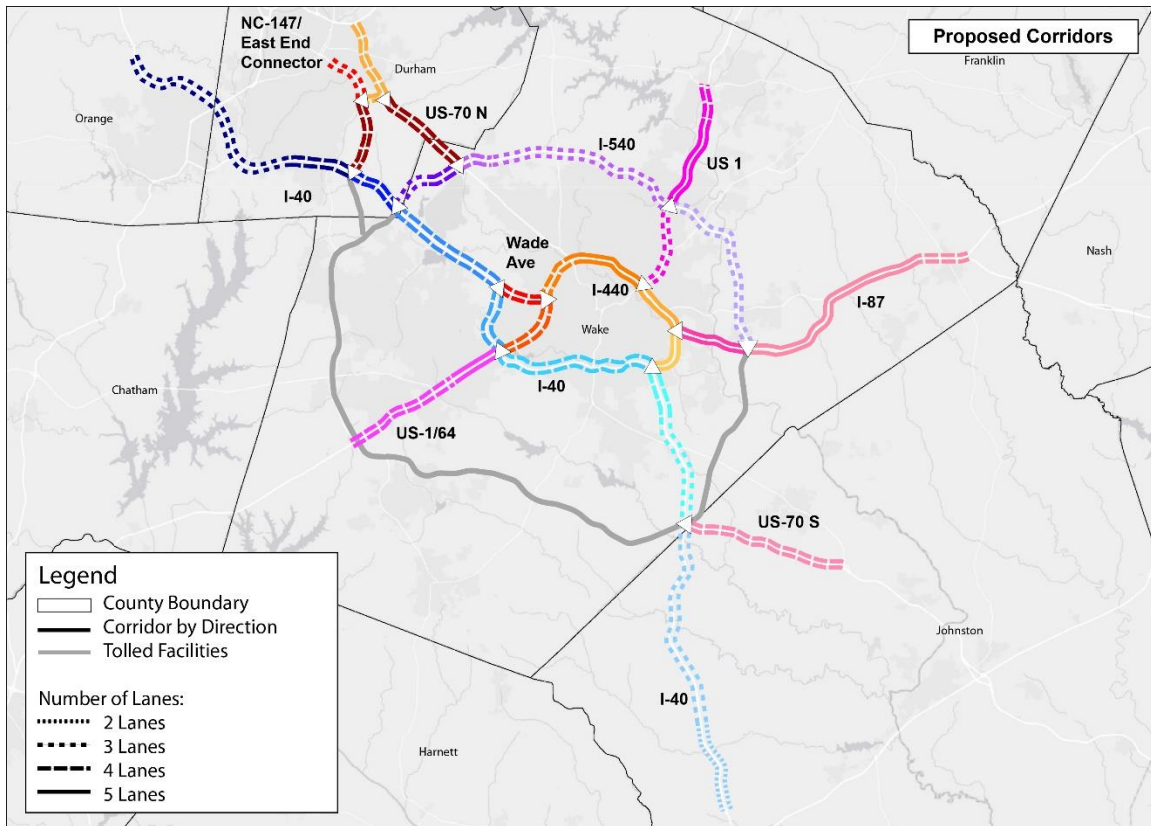

Figure 5-7 Updated Corridors Map

The TRM’s 2045 outputs were fed into a Toll Optimization Model (TOM) ©, a special suite of models designed to identify lane volumes, toll levels, and travel times for tolled highways. TOM inputs included:

- Corridor volumes
- Demographic conditions
- Values of time
- Traffic composition
- Roadway geometry

The TOM analysis used the following assumptions:

- All users pay for corridor use
- Buses and vanpools travel for free

The TOM results are a general indication of a corridor’s performance. Figure 5-8 and Figure 5-9 display TOM results for this system of express lanes in 2045: 1) estimated annual revenue collection per mile and 2) travel time savings per mile.

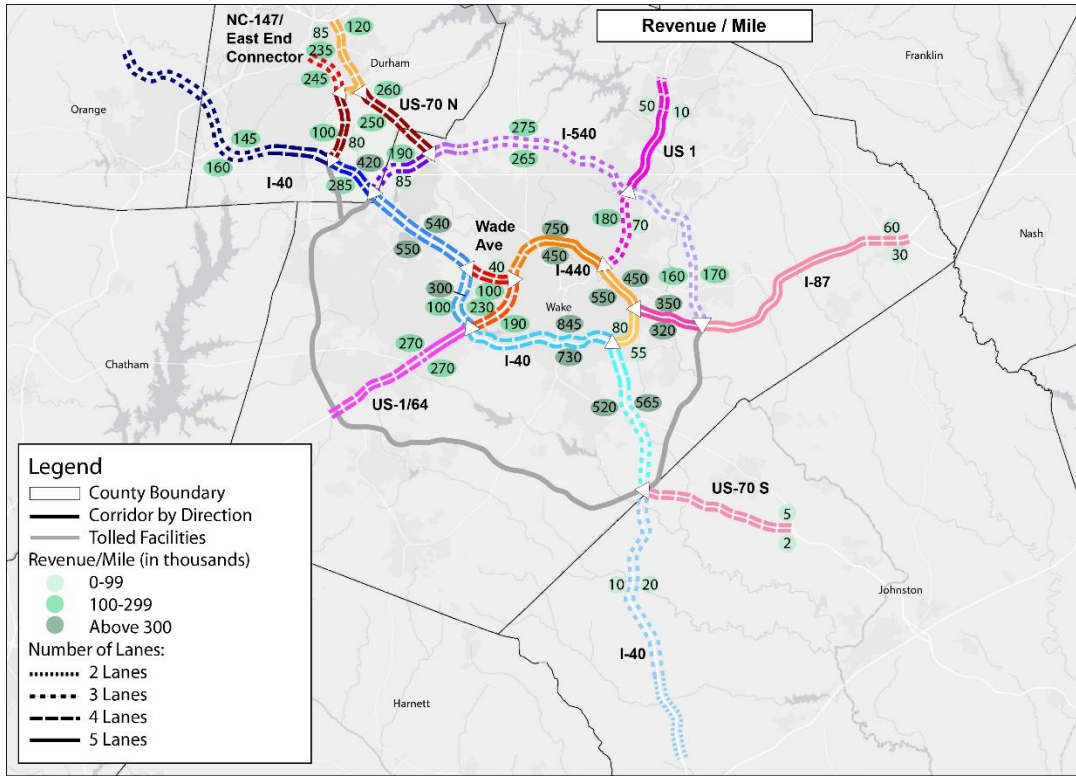

Figure 5-8 TOM results for Revenue per Mile

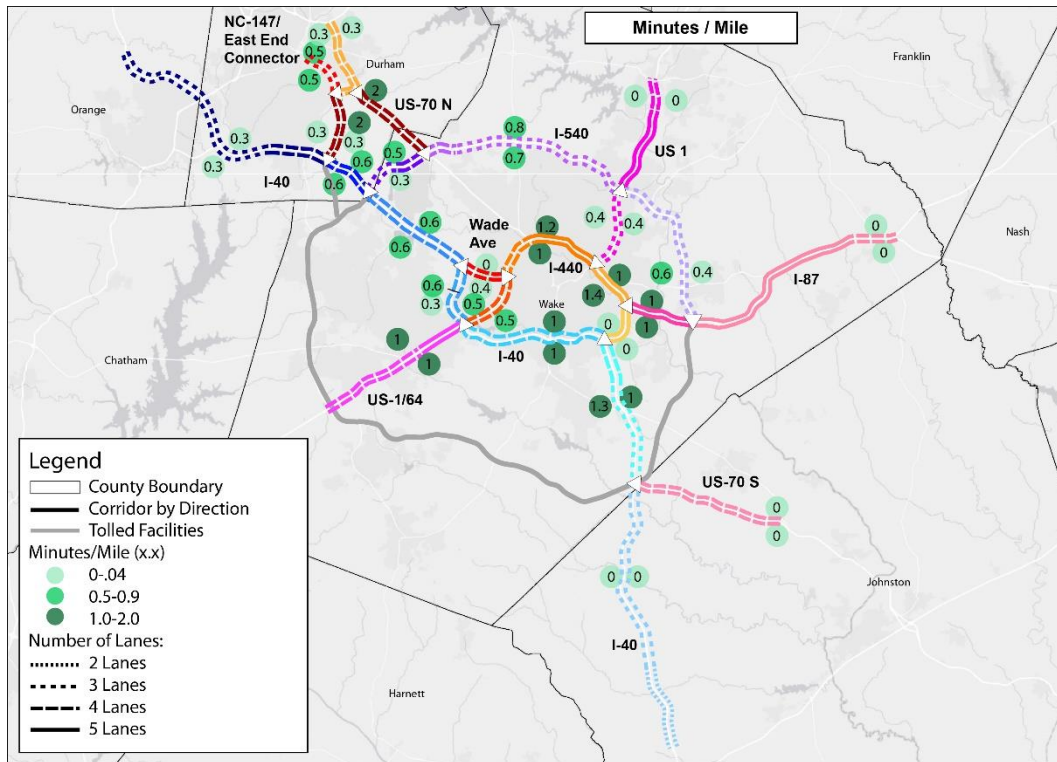

Figure 5-9 TOM Results for Minutes per Mile

On September 20, 2018, the Stakeholder Oversight Team (SOT) reviewed the initial screening results. Meeting attendees included representatives of CAMPO, DCHC MPO, NCDOT, NCTA, RTA and Go-Triangle. During the review of corridor toll revenues and travel times, SOT members made the following suggestions:

- Extend the I-40 express lanes west to the NC-54 interchange to provide direct access to Chapel Hill
- Include the East End Connector because of its importance in connecting the NC-147 and US-70 corridors east of Durham.
- Include NC-147 west to the Alston Avenue interchange.
- Include Wade Avenue between I-40 and I-440 based on system connectivity benefits.

Figure 5-10 is a regional map of the corridors advancing to Tier 2 screening.

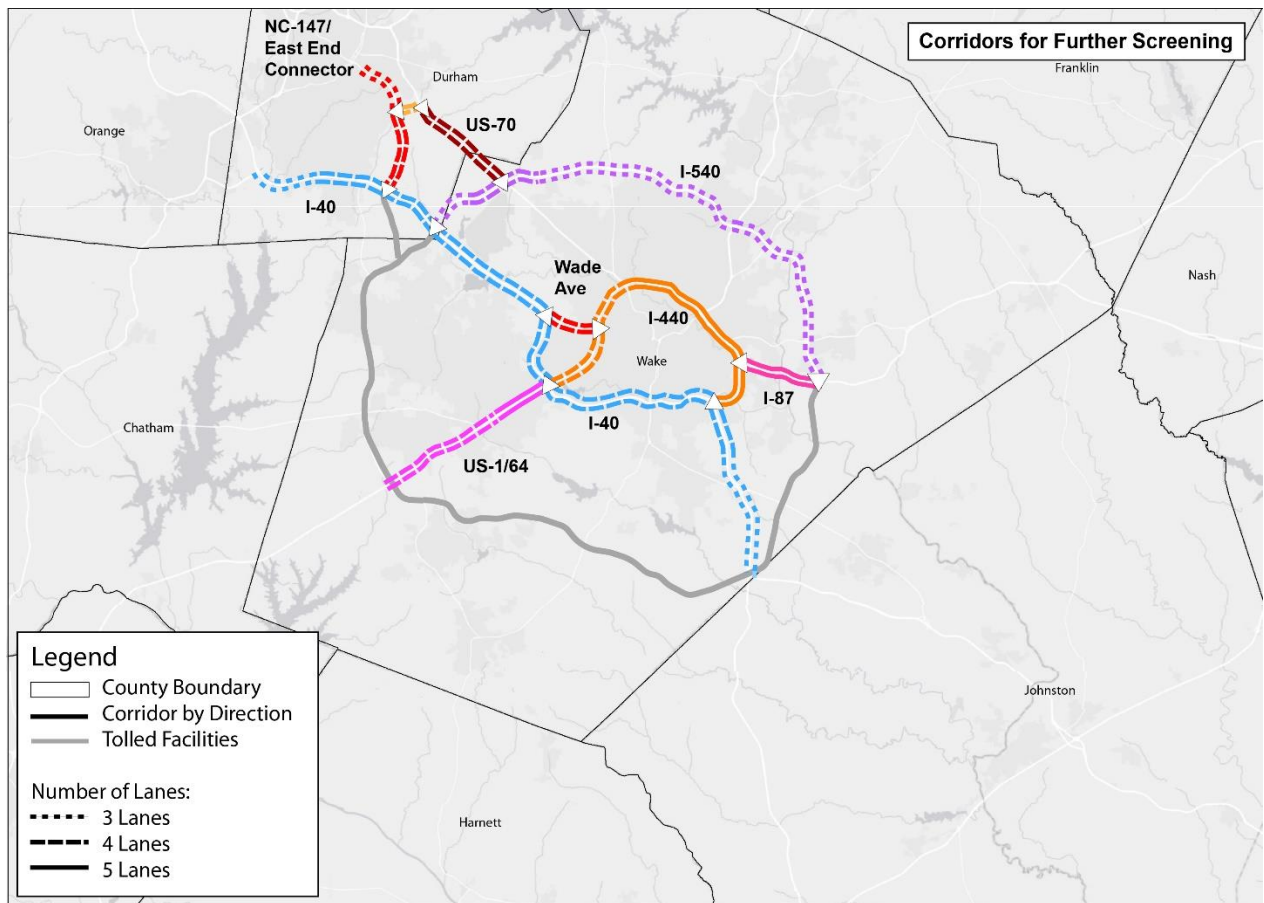

Figure 5-10 Corridors Advancing to Tier 2 Screening

5.2 TIER 2 CORRIDOR EVALUATION

The following corridors met the screening criteria and were recommended for detailed study during Tier 2:

- I-40 between NC-54 and US-70
- I-440 between US-1 and I-40
- I-540 between I-40 and I-87
- US-1/US-64 between I-540 and I-440
- I-87 between I-440 and I-540
- NC-147 between Alston Avenue and I-40
- US-70 between NC-147 and I-540
- Wade Avenue between I-40 and I-440

EVALUATION CRITERIA

REVENUE AND USER CHARGE FORECASTS

As mentioned in the preceding chapter, express lane revenues were estimated using the TOM. This suite of models used TRM demand forecasts to test future performance of express lane facilities. Revenue collection estimates were based on the following assumptions:

- Horizon year of 2045
- All express lane users pay
- Buses and vanpools use the express lane for free
- Full-time express lane operations
- Variable dynamic pricing (tolls change in near real time based on demand levels)

Average peak hour tolls were estimated for each corridor based on the assumptions listed above. The average user charge per mile ranged from \$0.05 (Wade Avenue) to \$0.57 (US-70). The average charge per mile for the remaining eight corridors was \$0.29. As a comparison, the I-77 Express lanes in Charlotte will open this fall at a rate of \$0.36 per mile, or \$9.40 for the entire 26-mile facility.

CONSTRUCTION COSTS

The cost for implementing express lanes along the Tier 2 corridors was estimated using a planning-level methodology developed for the Charlotte Regional Transportation Organization for the agency's *Long Range Transportation Plan*. Estimates were prepared for two design approaches:

- “Full feature” using widths preferred by NCDOT for shoulders and lanes and for the buffer separation between the express lane and the adjacent general-purpose lane. This approach maximizes roadway safety and upgrades the roadway to current design standards. It also provides sufficient shoulder widths for breakdowns and passing stalled vehicles. This approach provides ultimate or build-out cost estimates.
- “Constrained” using design exceptions where needed. Under this approach, widening for new express lanes would be minimized as much as possible to remain within the existing paved cross-section, or certainly the right-of-way. If needed, travel lanes and the inside shoulder would be narrowed, assuming they have not been narrowed previously. This approach lowers construction costs by minimizing bridge replacements and interchange, property and utility impacts. Where feasible, shoulders would be used to add express lanes.

The costs for direct connections to express lanes were not estimated.

TRAVEL TIME SAVINGS

A primary benefit of express lanes is travel time savings for commuters and other motorists. On average, vehicles in express lanes travel at a higher rate of speed and with fewer delays than vehicles using general purpose lanes in the same corridors. For this study, the estimated time saved during peak periods by express lane users was compared to motorists traveling in the general-purpose lanes. An estimated savings of a half-minute per mile for longer corridors is a generally-accepted measure for express lane attractiveness. TOM was used to estimate travel time savings in each of the study corridors.

TRIP DEPENDABILITY

This factor used the Buffer Time Index developed by the Federal Highway Administration (FHWA). Buffer time is the extra time you must plan for when traveling during high traffic periods to make sure you arrive at your destination on time. Examples include a trip to work, to the airport for a flight, or picking up your child at daycare to avoid a penalty for late arrival. If a trip typically takes 20 minutes with minimal traffic, a buffer time of 30 minutes means you should leave 50 minutes prior to your required arrival time. The use of buffer time may result in arriving at your destination early, but it ensures that congested traffic will not cause you to be late.

Routes with high buffer times are less predictable than routes with lower buffer times. Because express lanes usually have lower buffer times than general-purpose lanes, express lanes provide more operational certainty from day-to-day. Many highway users value trip dependability as much as travel time savings.

The TOM was used to estimate the buffer time index for the study corridors.

TRANSIT SUPPORTIVE

Express lanes complement regional transit service by allowing access to buses and vanpools and enhancing the speed and effectiveness of corresponding transit routes within a corridor. The TRM includes forecasted transit services for 2045. The regional transit routes using a significant portion of a study corridor were identified. Based on forecasted route frequency, the daily number of buses operating along the express lane in each corridor was estimated.

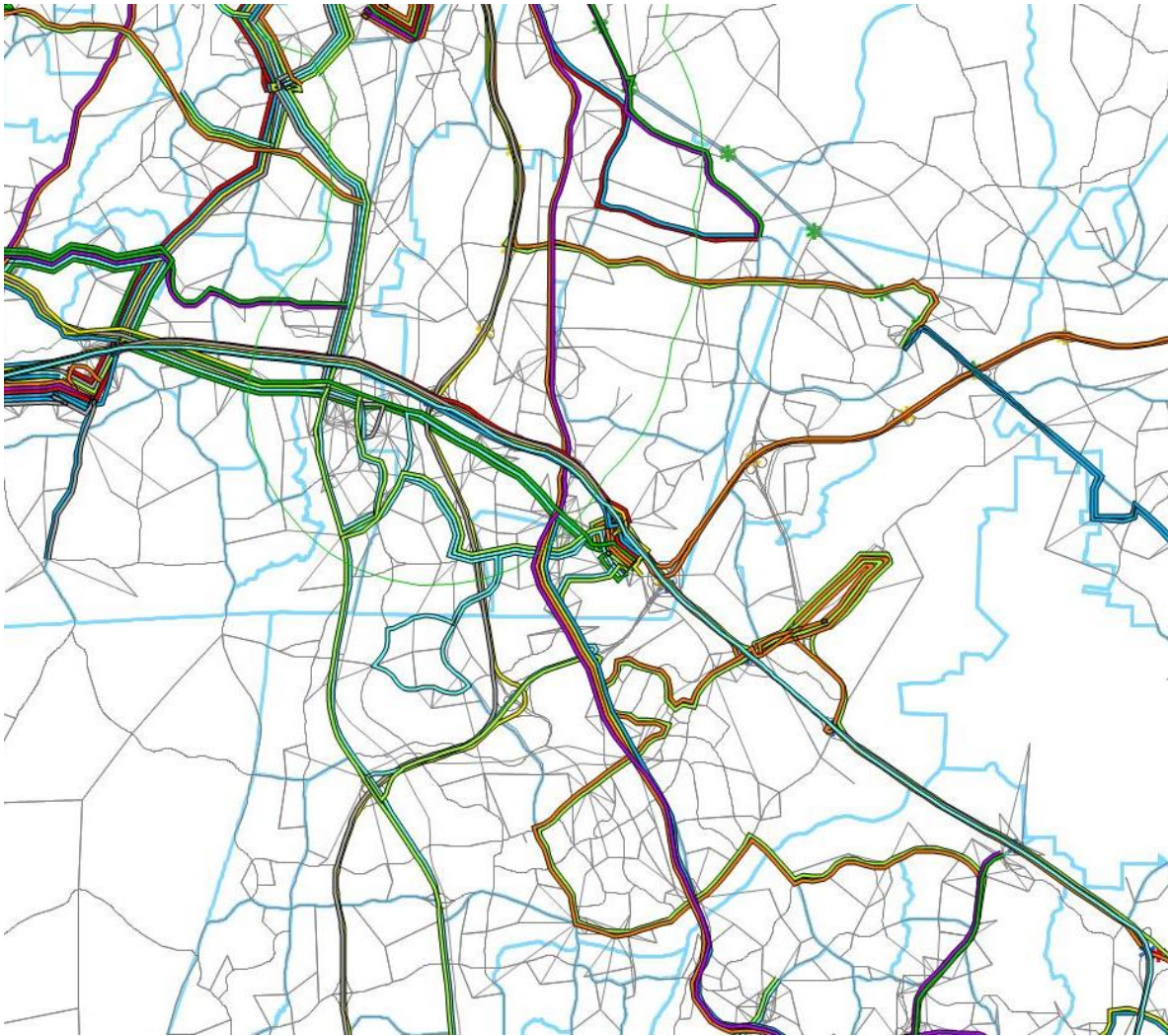

Figure 5-11 2045 Transit Routes in Triangle Regional Model

ACCESS TO JOBS

Because express lanes can create more commuter choices for traveling to and from work, forecasted employment at study corridor interchanges was determined. The TRM includes projected employment for 2045. The number of jobs projected within a two-mile buffer of each interchange was calculated categorized by type: Industry, Service, Office and Retail.

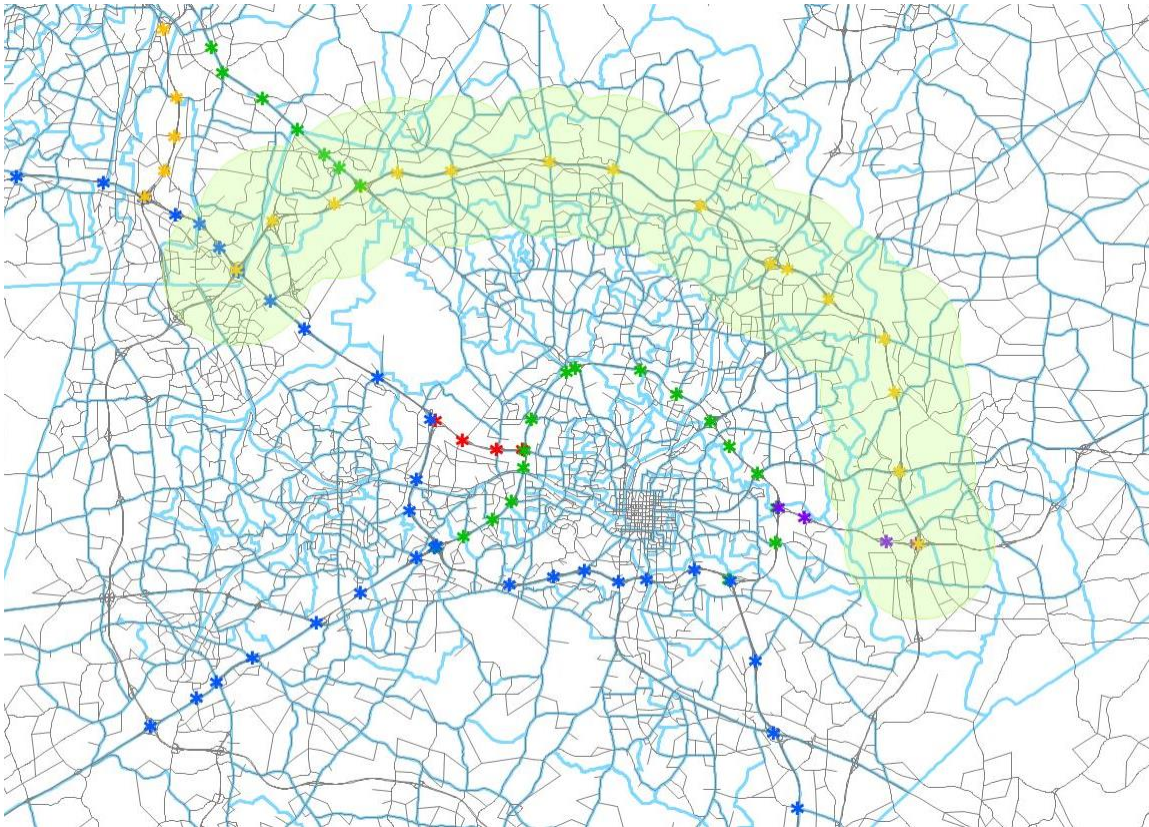

Figure 5-12 Buffered Areas of Low Income Populations along Corridor Intersections

IMPACTS ON LOW INCOME RESIDENTS

The perception of negative equity impacts with express lane implementation often plagues tolling projects. There is a concern that pricing roadways limits the options available to low-income travelers while simultaneously increasing the number of options available to higher-income users. Research into income-equity impacts of express lane implementation has shown that well-designed pricing approaches can help to mitigate such impacts and provide greater options for all travelers, regardless of income category.

Two approaches were used to estimate the impacts of express lanes on low income residents. The first used 2012-2016 American Census Survey (ACS) population data to estimate the number of households below the poverty level within a two-mile buffer of each interchange along the study corridors. The second approach focused on work trips with the understanding that reliable travel times are most important for work trips. It is during the peak hour that the travel time difference between express lanes and general-purpose lanes will be the greatest.

The TOM was used to generate peak hour travel times for each segment within the study corridors for both the general-purpose lanes and express lanes. The TRM was then used to generate travel times for all facilities in the Triangle region under a scenario with no express lane facilities. The travel times for the express lane corridors from the TRM were then replaced by the travel times from the TOM model.

The “skimming” procedure in TransCAD was used to generate zone-to-zone travel times for paths where drivers use the express lanes, and travel paths where drivers use only the general-purpose lanes.

As expected, the express lanes scenario generated faster travel times between zones. The difference between these two scenarios is the zone-to-zone travel time impact on drivers who do not use the express lanes, either by choice or financial limitation. Travel time differences less than five minutes were ignored because they are not perceived to have a significant impact on travel behavior. The zone pairs with a travel time impact greater than five minutes were identified for further analysis.

To evaluate the potential magnitude of travel time impact on low income households, the low income/one-car household work trips output from the TRM were used. These trips were multiplied by the zone-to-zone travel time for all zone pairs with travel time greater than or equal to five minutes. The resulting data was useful for identifying the travel time impact on low income work trips. The results were grouped by origin zone to get the total low income work trips affected, along with the aggregated travel time impact per zone.

TRAVEL TIME CHANGES

The impact of managed lanes on low income households in the Triangle region is minimal. Approximately 1,000 trips out of a total of 96,000 low income work trips in the Triangle region experienced an increase in travel time greater than five minutes with the implementation of express lanes. This equals about 1 percent of the work trips from low income households, with an average of eight minutes of additional travel time. Figure 5-13 shows the zones which have the highest aggregated travel time impact in blue with lighter shades denoting lesser impact. The size of the dots denotes the number of trips affected for those zones, for zones with more than five trips affected.

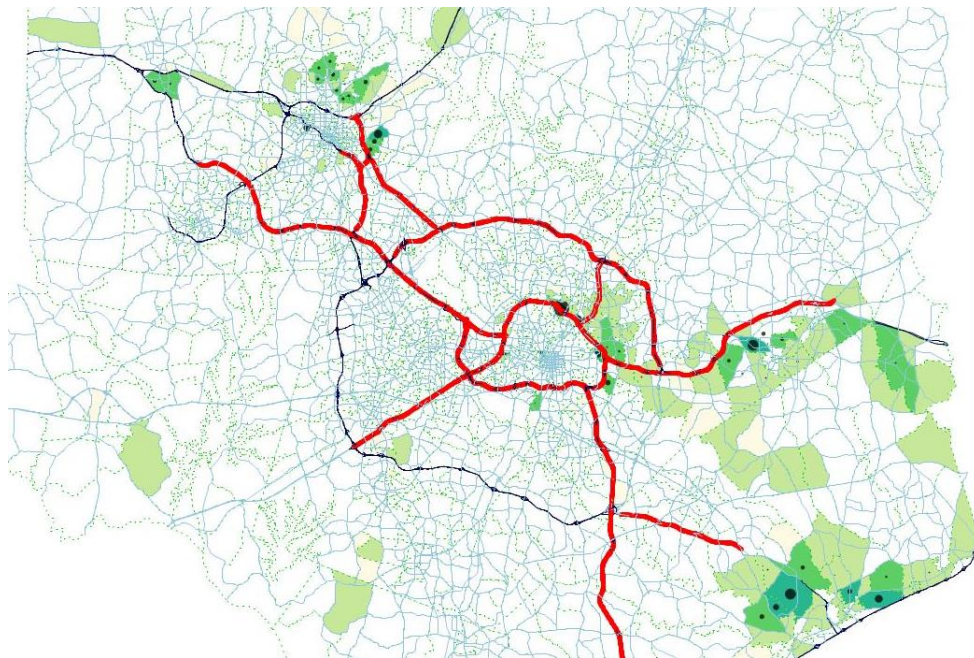

Figure 5-13 Zones with Significant Impact of Managed Lanes on Low Income Households

RESIDENTIAL AREAS

Figure 5-14 provides a geographic representation of the zones with the highest travel time impact. These zones are located around Northeast Raleigh, North and East Durham, South Hillsborough and the Selma-Smithfield area. Most of these zones are clustered around highways, suggesting that most trips originating from those neighborhoods would depend on those highway corridors for travel.

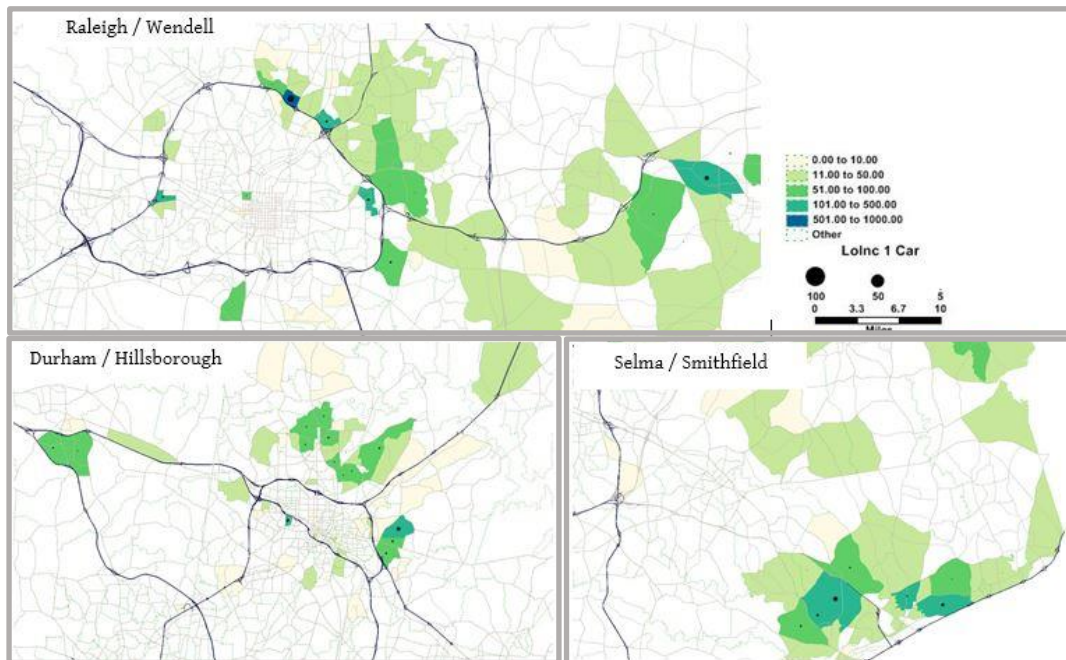

Figure 5-14 Concentrations of Zones with Significant Impact

CORRIDOR RESULTS

Tier 2 evaluation results are summarized in corridor fact sheets shown on the following pages. The I-40 corridor was divided into the following three segments to facilitate data collection for evaluation:

- West: NC-54 to NC-147
- Central: NC-147 to US-1/US-64
- South: US-1/US-64 to US-70

As discussed in the previous section, construction costs for express lane implementation were estimated using two design approaches. Appendix A compares the existing cross-section to the “full feature” and “constrained” design cross-sections for each of the 10 study corridors.

TRIANGLE STRATEGIC TOLLING STUDY

I-40: NC 54- NC 147

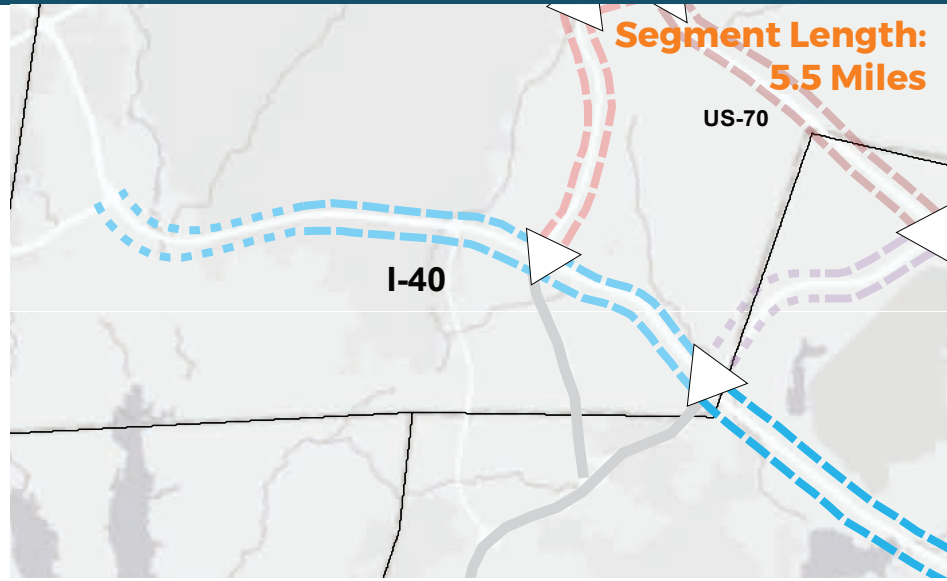
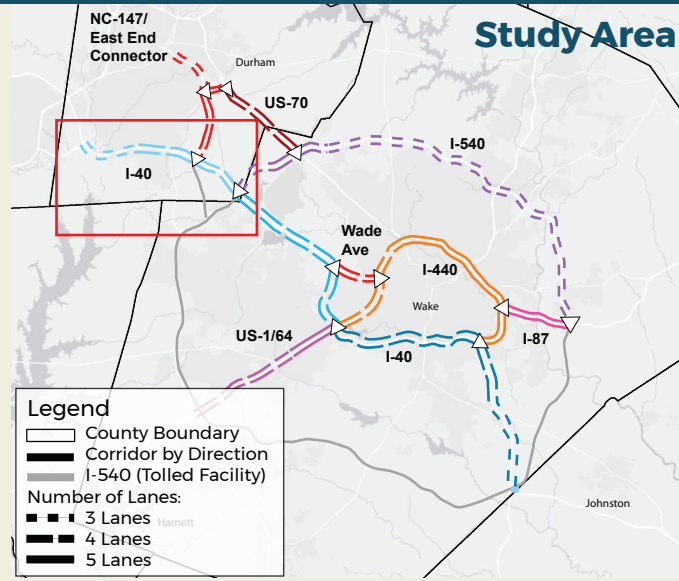

2045 Peak Travel Time Savings General Purpose vs Express Lanes



	AM Peak	PM Peak
East Bound	0.4 Min/Mile	0.2 Min/Mile
West Bound	0.2 Min/Mile	0.4 Min/Mile

2045 Peak Period Tolls



Corridor	\$1.60
Per Mile	\$0.32

2045 Annual Toll Revenues



East Bound	\$235,000/mile
West Bound	\$175,000/mile

Estimated Construction Cost



**\$8 - \$14
million/mile**

2045 Employees by Employment Type*

**100,000
TOTAL EMPLOYEES**

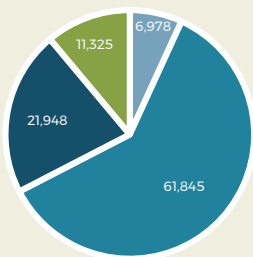

Industry Service
Office Retail

Travel Time Dependability (Buffer Time Index)

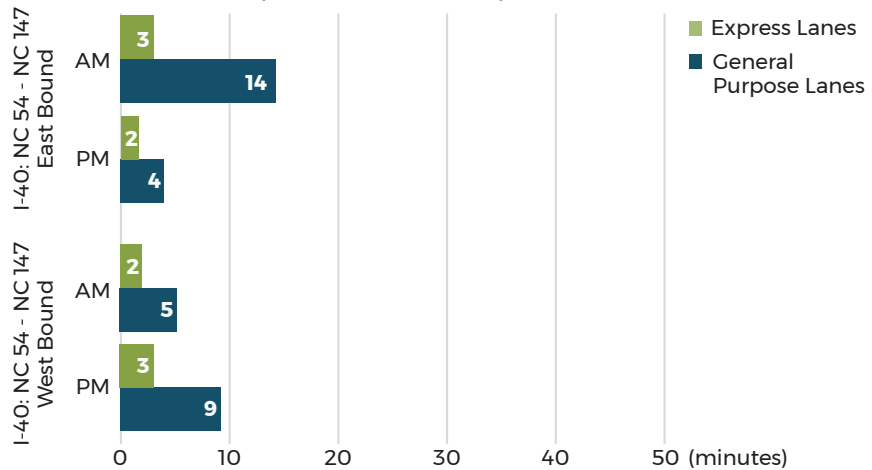

Buffer time is the extra time you must plan for when traveling during times of high traffic to make sure you arrive on time. This could be a trip to work, the airport for a flight, or picking up your child from daycare to avoid the penalty for arriving late. If a trip would take 20 minutes with no traffic, and the buffer time is 30 minutes, you should leave 50 minutes before needing to arrive. Using buffer time, you may arrive early, but it is a way of making sure bad traffic won't make you late.

Routes with high buffer times are less predictable than routes with lower buffer times. The fact that express lanes usually have less buffer time than general purpose lanes shows that express lanes have greater certainty in how it will perform from day to day. This is one of the key features of express lanes.

Percent of the Population Below the Poverty Level*



10%

Future Year Daily Buses**



72

* Within a 2 mile buffer from selected corridor based off the Triangle Regional Model

** Routes that are along some segment of the corridor

TRIANGLE STRATEGIC TOLLING STUDY

I-40: US 147 - US 1

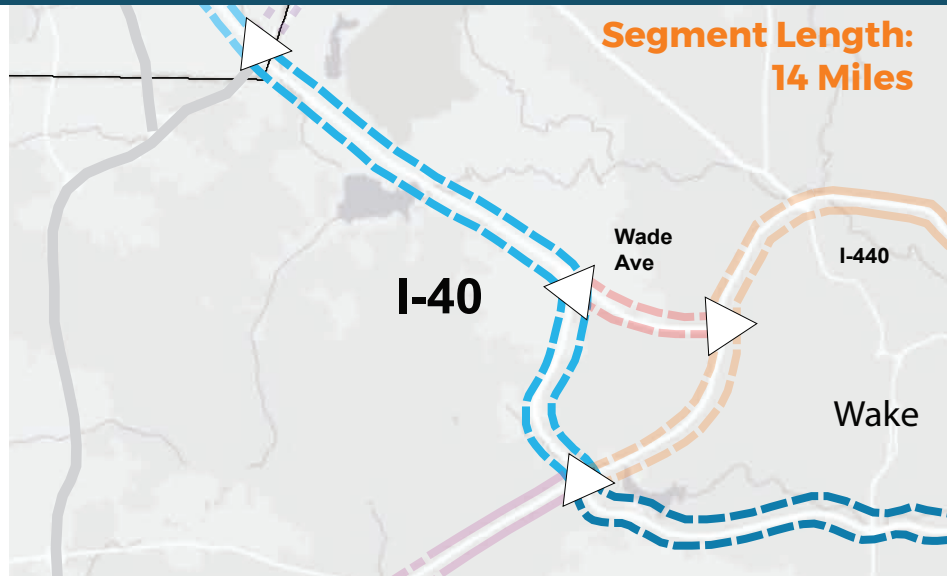
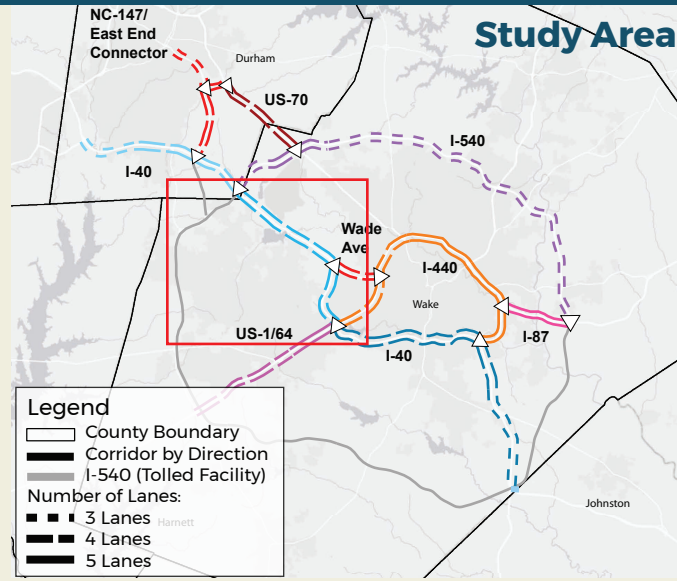

2045 Peak Travel Time Savings General Purpose vs Express Lanes



	AM Peak	PM Peak
East Bound	0.6 Min/Mile	0.2 Min/Mile
West Bound	0.2 Min/Mile	0.5 Min/Mile

2045 Peak Period Tolls



Corridor	\$4.00
Per Mile	\$0.29

2045 Annual Toll Revenues



East Bound	\$450,000/mile
West Bound	\$355,000/mile

Estimated Construction Cost



\$10 - \$16 million/mile

2045 Employees by Employment Type*

235,000
TOTAL EMPLOYEES

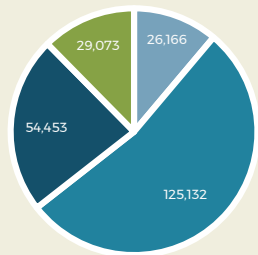

■ Industry ■ Service
■ Office ■ Retail

Travel Time Dependability (Buffer Time Index)

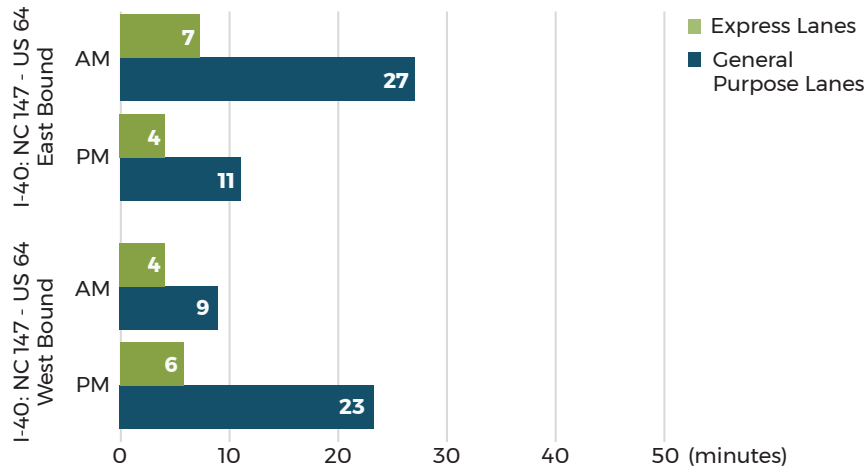

Buffer time is the extra time you must plan for when traveling during times of high traffic to make sure you arrive on time. This could be a trip to work, the airport for a flight, or picking up your child from daycare to avoid the penalty for arriving late. If a trip would take 20 minutes with no traffic, and the buffer time is 30 minutes, you should leave 50 minutes before needing to arrive. Using buffer time, you may arrive early, but it is a way of making sure bad traffic won't make you late.

Routes with high buffer times are less predictable than routes with lower buffer times. The fact that express lanes usually have less buffer time than general purpose lanes shows that express lanes have greater certainty in how it will perform from day to day. This is one of the key features of express lanes.

Percent of the Population Below the Poverty Level*



13%

Future Year Daily Buses**



160

* Within a 2 mile buffer from selected corridor based off the Triangle Regional Model
** Routes that are along some segment of the corridor

TRIANGLE STRATEGIC TOLLING STUDY

I-40: US 1 - US 70

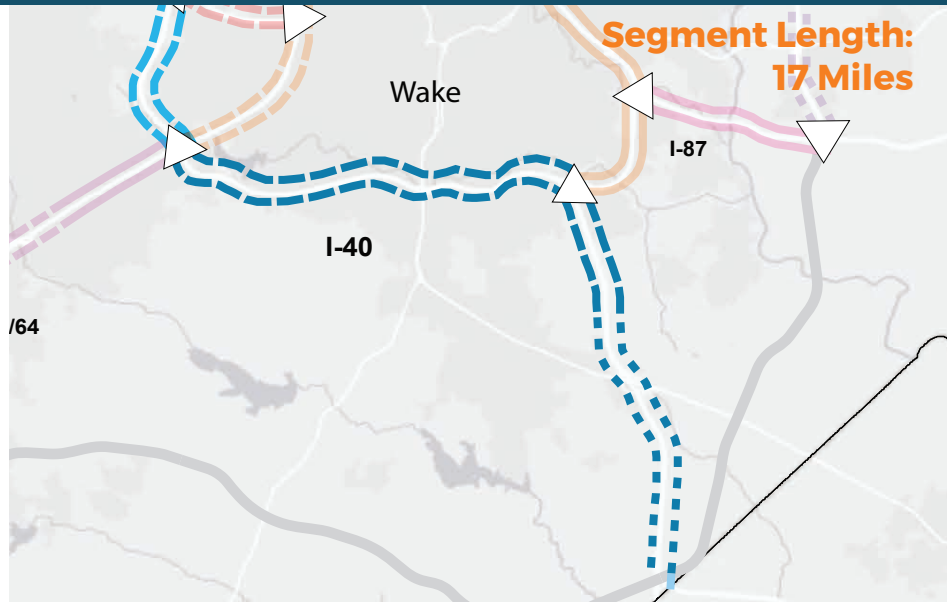
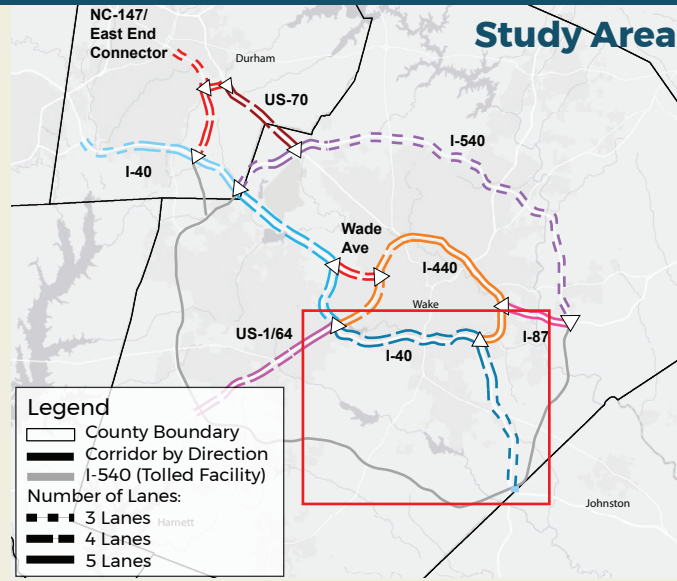

2045 Peak Travel Time Savings General Purpose vs Express Lanes



	AM Peak	PM Peak
East Bound	0.9 Min/Mile	0.1 Min/Mile
West Bound	0.1 Min/Mile	1.2 Min/Mile

2045 Peak Period Tolls



Corridor	\$4.50
Per Mile	\$0.25

2045 Annual Toll Revenues



East Bound	\$695,000/mile
West Bound	\$630,000/mile

Estimated Construction Cost



**\$8 - \$12
million/mile**

2045 Employees by Employment Type*

**230,000
TOTAL EMPLOYEES**

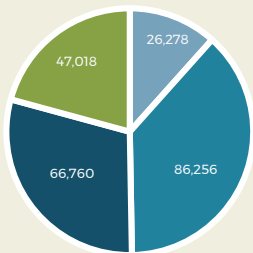

- Industry
- Service
- Office
- Retail

Travel Time Dependability (Buffer Time Index)

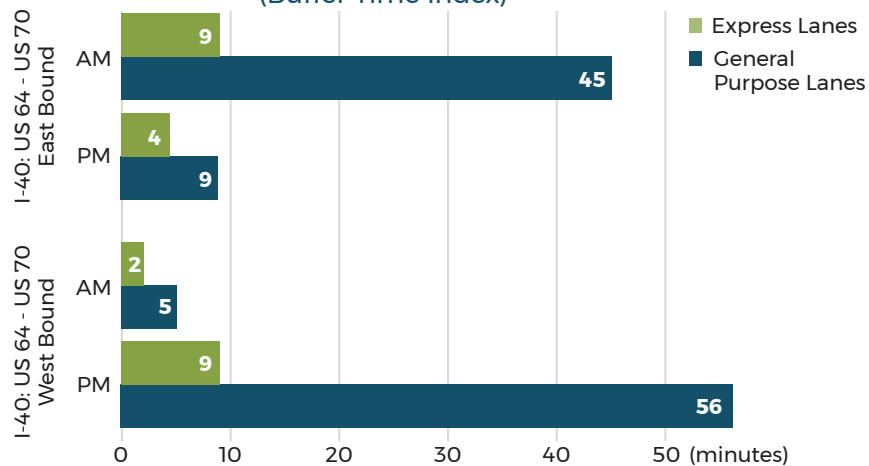

Buffer time is the extra time you must plan for when traveling during times of high traffic to make sure you arrive on time. This could be a trip to work, the airport for a flight, or picking up your child from daycare to avoid the penalty for arriving late. If a trip would take 20 minutes with no traffic, and the buffer time is 30 minutes, you should leave 50 minutes before needing to arrive. Using buffer time, you may arrive early, but it is a way of making sure bad traffic won't make you late.

Routes with high buffer times are less predictable than routes with lower buffer times. The fact that express lanes usually have less buffer time than general purpose lanes shows that express lanes have greater certainty in how it will perform from day to day. This is one of the key features of express lanes.

Percent of the Population Below the Poverty Level*



25%

Future Year Daily Buses**



12

* Within a 2 mile buffer from selected corridor based off the Triangle Regional Model
** Routes that are along some segment of the corridor

TRIANGLE STRATEGIC TOLLING STUDY

I-440

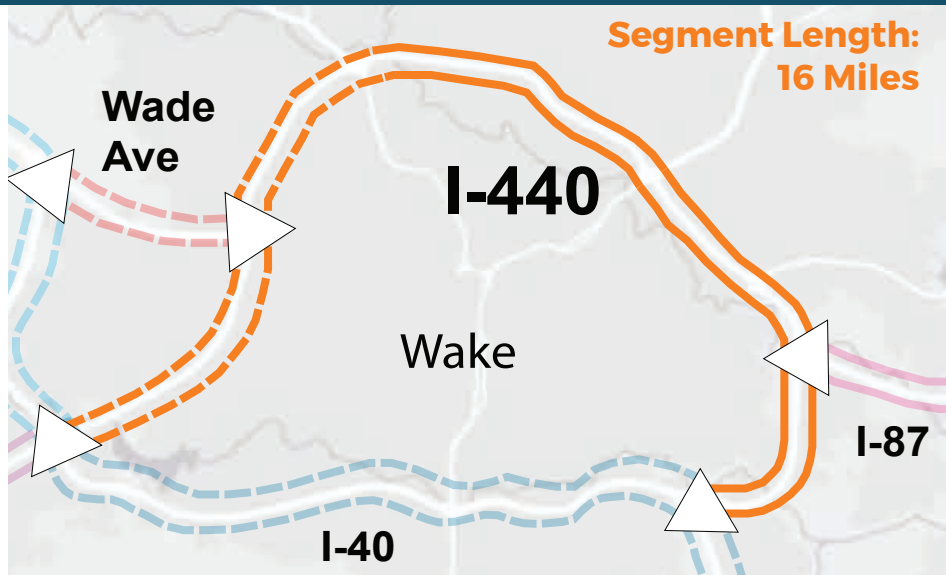
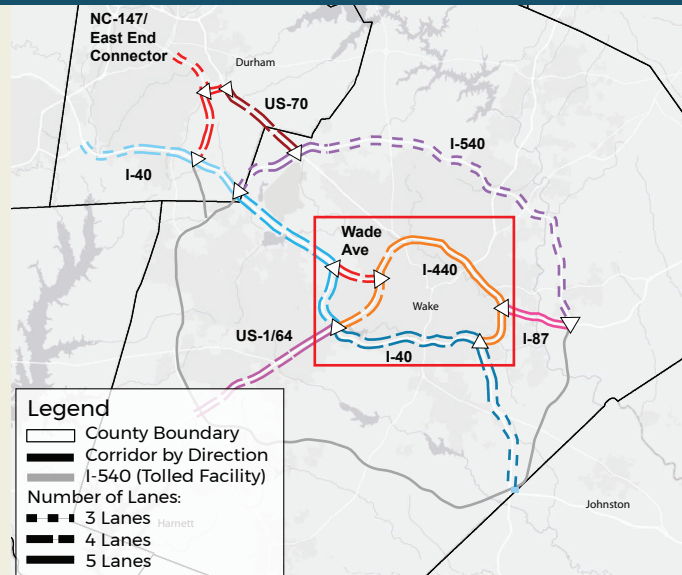

2045 Peak Travel Time Savings General Purpose vs Express Lanes



	AM Peak	PM Peak
East Bound	0.2 Min/Mile	0.7 Min/Mile
West Bound	0.7 Min/Mile	0.3 Min/Mile

2045 Peak Period Tolls



Corridor	\$5.40
Per Mile	\$0.32

2045 Annual Toll Revenues



East Bound	\$375,000/mile
West Bound	\$470,000/mile

Estimated Construction Cost



\$10 - \$24 million/mile

2045 Employees by Employment Type*

300,000
TOTAL EMPLOYEES

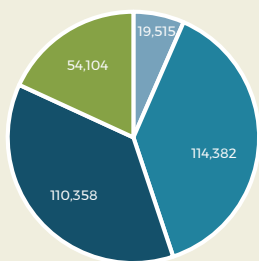

■ Industry ■ Service
■ Office ■ Retail

Travel Time Dependability (Buffer Time in Minutes)

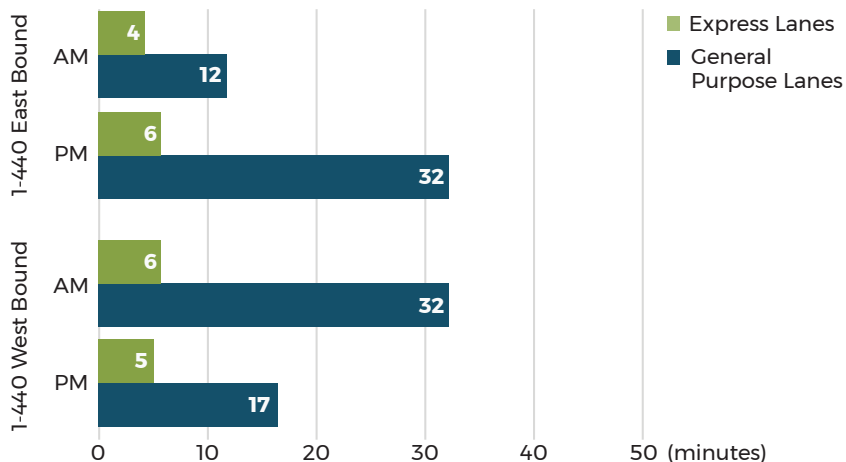

Buffer time is the extra time you must plan for when traveling during times of high traffic to make sure you arrive on time. This could be a trip to work, the airport for a flight, or picking up your child from daycare to avoid the penalty for arriving late. If a trip would take 20 minutes with no traffic, and the buffer time is 30 minutes, you should leave 50 minutes before needing to arrive. Using buffer time, you may arrive early, but it is a way of making sure bad traffic won't make you late.

Routes with high buffer times are less predictable than routes with lower buffer times. The fact that express lanes usually have less buffer time than general purpose lanes shows that express lanes have greater certainty in how it will perform from day to day. This is one of the key features of express lanes.

Percent of the Population Below the Poverty Level*



19%

Future Year Daily Buses**



100

* Within a 2 mile buffer from selected corridor based off the Triangle Regional Model

** Routes that are along some segment of the corridor

TRIANGLE STRATEGIC TOLLING STUDY

I-540

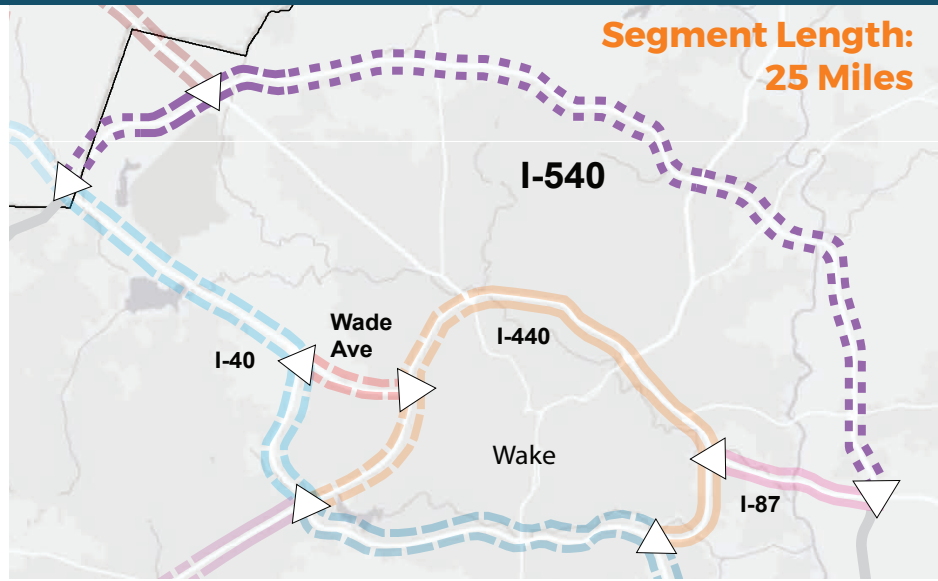
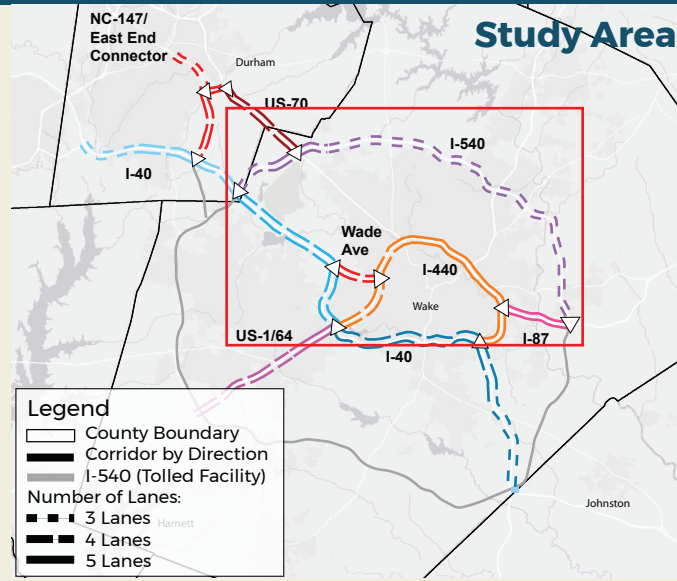

2045 Peak Travel Time Savings General Purpose vs Express Lanes



	AM Peak	PM Peak
East Bound	0 Min/Mile	0.6 Min/Mile
West Bound	0.6 Min/Mile	0 Min/Mile

2045 Peak Period Tolls



Corridor	\$6.80
Per Mile	\$0.27

2045 Annual Toll Revenues



East Bound	\$200,000/mile
West Bound	\$225,000/mile

Estimated Construction Cost



\$4 - \$17 million/mile

2045 Employees by Employment Type*

165,000
TOTAL EMPLOYEES

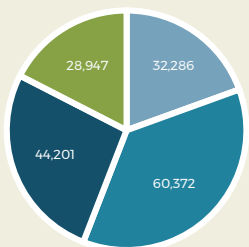

Industry Service
Office Retail

Travel Time Dependability (Buffer Time Index)

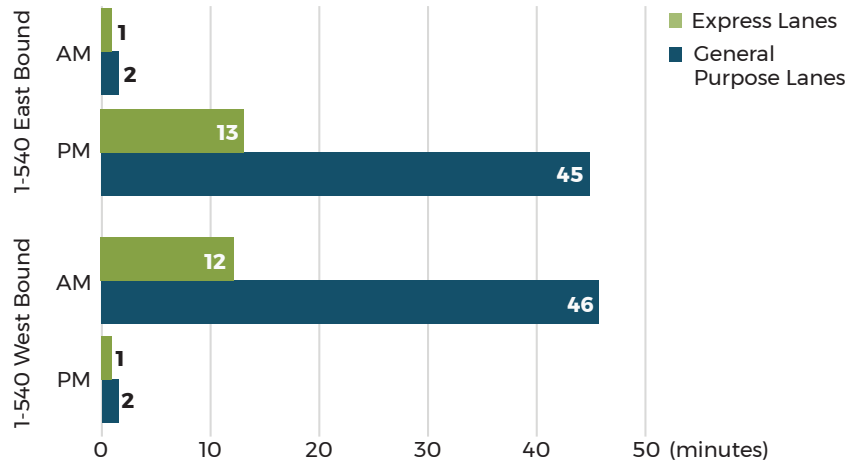

Buffer time is the extra time you must plan for when traveling during times of high traffic to make sure you arrive on time. This could be a trip to work, the airport for a flight, or picking up your child from daycare to avoid the penalty for arriving late. If a trip would take 20 minutes with no traffic, and the buffer time is 30 minutes, you should leave 50 minutes before needing to arrive. Using buffer time, you may arrive early, but it is a way of making sure bad traffic won't make you late.

Routes with high buffer times are less predictable than routes with lower buffer times. The fact that express lanes usually have less buffer time than general purpose lanes shows that express lanes have greater certainty in how it will perform from day to day. This is one of the key features of express lanes.

Percent of the Population Below the Poverty Level*



8%

Future Year Daily Buses**



18

* Within a 2 mile buffer from selected corridor based off the Triangle Regional Model
** Routes that are along some segment of the corridor

TRIANGLE STRATEGIC TOLLING STUDY

US 1 - US 64

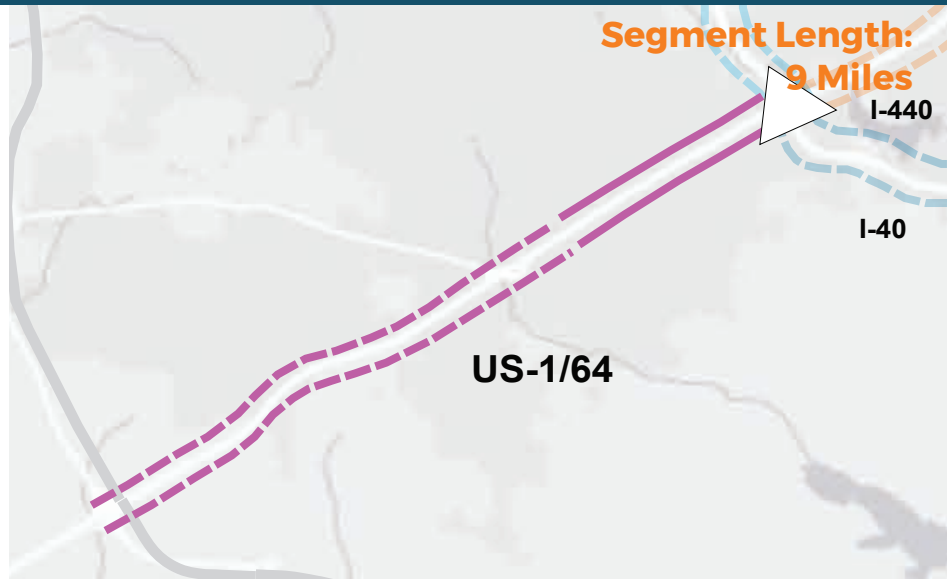
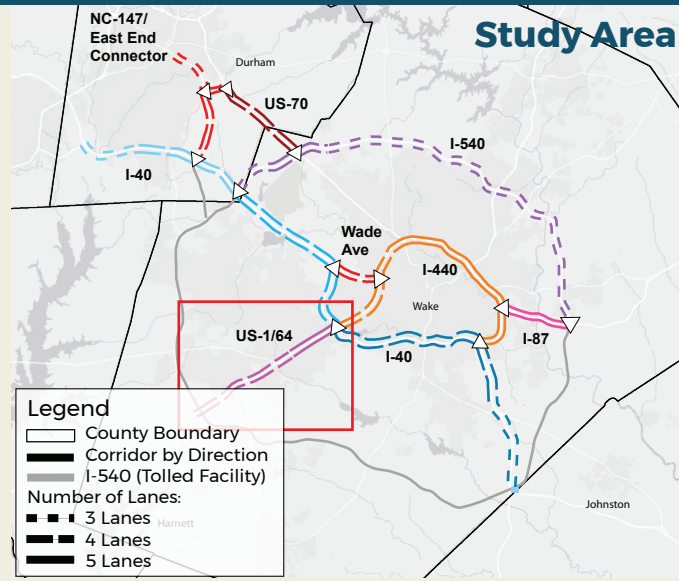

2045 Peak Travel Time Savings General Purpose vs Express Lanes



	AM Peak	PM Peak
East Bound	0.8 Min/Mile	0 Min/Mile
West Bound	0 Min/Mile	0.8 Min/Mile

2045 Peak Period Tolls



Corridor	\$3.20
Per Mile	\$0.35

2045 Annual Toll Revenues



East Bound	\$270,000/mile
West Bound	\$270,000/mile

Estimated Construction Cost



\$7 - \$25 million/mile

2045 Employees by Employment Type*

110,000
TOTAL EMPLOYEES

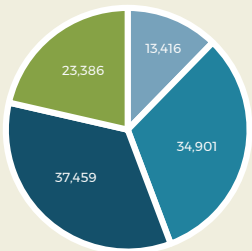

■ Industry ■ Service
■ Office ■ Retail

Travel Time Dependability (Buffer Time Index)

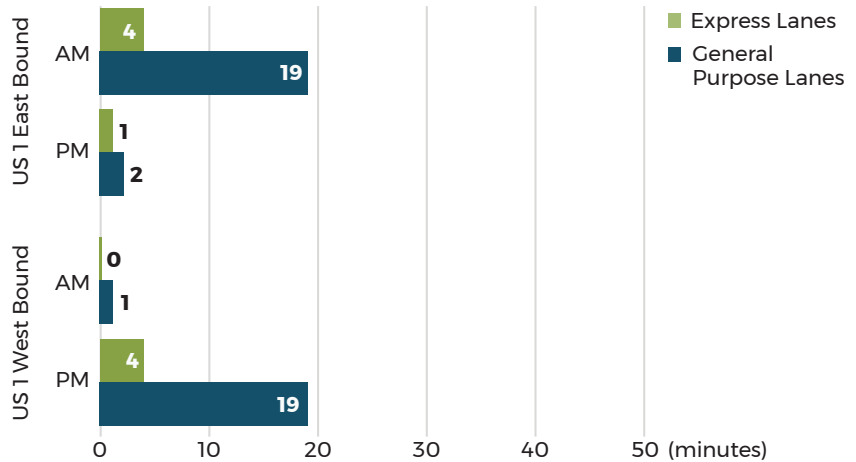

Buffer time is the extra time you must plan for when traveling during times of high traffic to make sure you arrive on time. This could be a trip to work, the airport for a flight, or picking up your child from daycare to avoid the penalty for arriving late. If a trip would take 20 minutes with no traffic, and the buffer time is 30 minutes, you should leave 50 minutes before needing to arrive. Using buffer time, you may arrive early, but it is a way of making sure bad traffic won't make you late.

Routes with high buffer times are less predictable than routes with lower buffer times. The fact that express lanes usually have less buffer time than general purpose lanes shows that express lanes have greater certainty in how it will perform from day to day. This is one of the key features of express lanes.

Percent of the Population Below the Poverty Level*



11%

Future Year Daily Buses**



24

* Within a 2 mile buffer from selected corridor based off the Triangle Regional Model
** Routes that are along some segment of the corridor

TRIANGLE STRATEGIC TOLLING STUDY

I-87

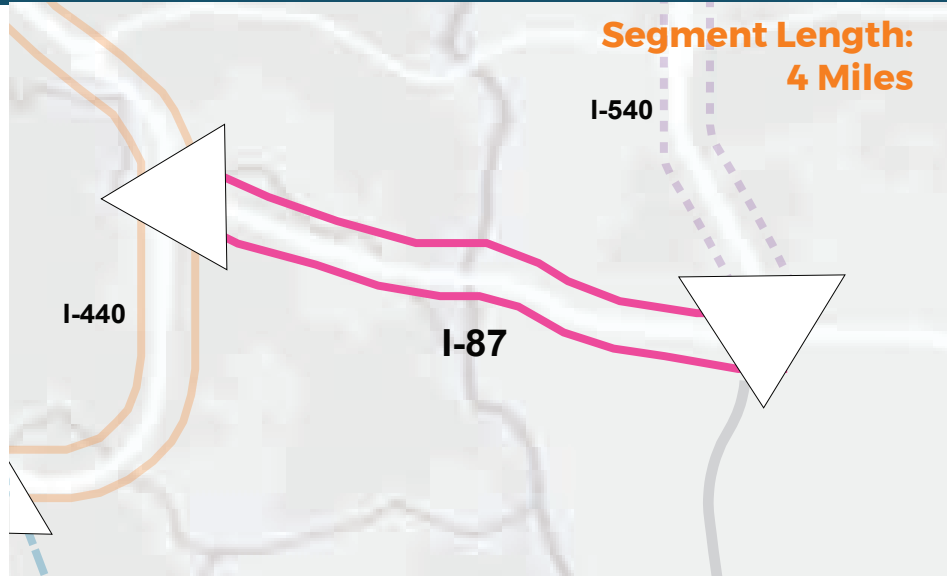
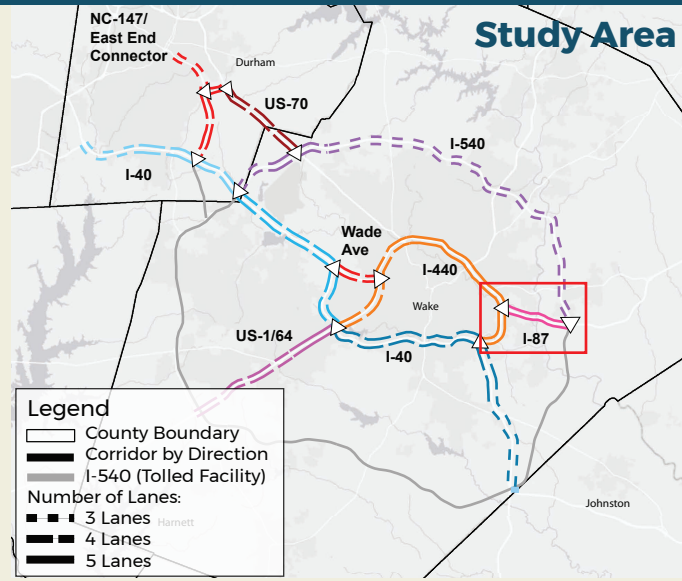

2045 Peak Travel Time Savings General Purpose vs Express Lanes



	AM Peak	PM Peak
East Bound	0 Min/Mile	1 Min/Mile
West Bound	1 Min/Mile	0 Min/Mile

2045 Peak Period Tolls



Corridor	\$1.40
Per Mile	\$0.35

2045 Annual Toll Revenues



East Bound	\$320,000/mile
West Bound	\$350,000/mile

Estimated Construction Cost



\$9 - \$20 million/mile

2045 Employees by Employment Type*

50,000
TOTAL EMPLOYEES

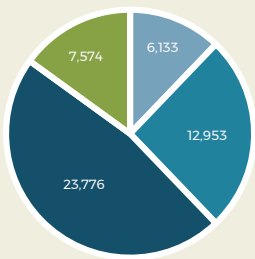

Industry Service
Office Retail

Travel Time Dependability (Buffer Time Index)

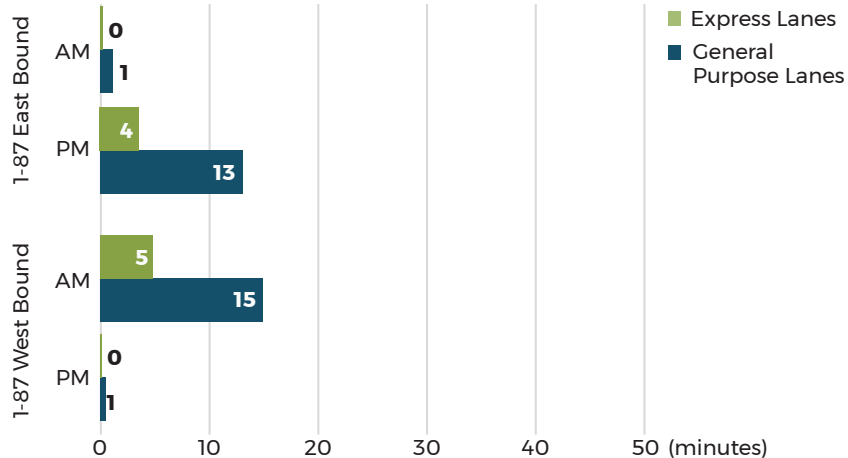

Buffer time is the extra time you must plan for when traveling during times of high traffic to make sure you arrive on time. This could be a trip to work, the airport for a flight, or picking up your child from daycare to avoid the penalty for arriving late. If a trip would take 20 minutes with no traffic, and the buffer time is 30 minutes, you should leave 50 minutes before needing to arrive. Using buffer time, you may arrive early, but it is a way of making sure bad traffic won't make you late.

Routes with high buffer times are less predictable than routes with lower buffer times. The fact that express lanes usually have less buffer time than general purpose lanes shows that express lanes have greater certainty in how it will perform from day to day. This is one of the key features of express lanes.

Percent of the Population Below the Poverty Level*



16%

Future Year Daily Buses**



12

* Within a 2 mile buffer from selected corridor based off the Triangle Regional Model
** Routes that are along some segment of the corridor

TRIANGLE STRATEGIC TOLLING STUDY

NC 147

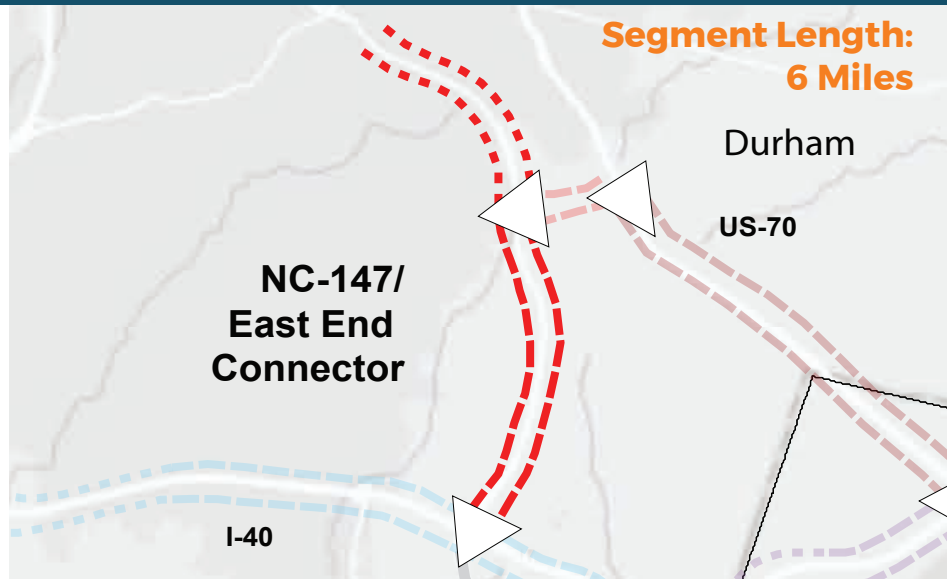
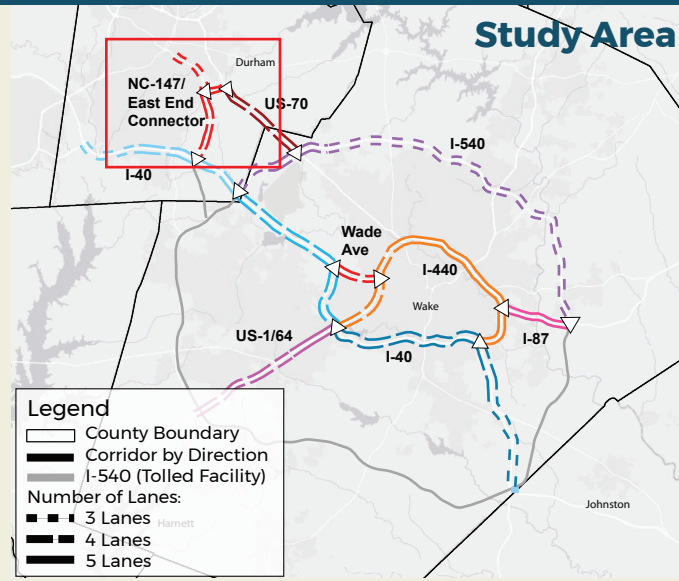

2045 Peak Travel Time Savings General Purpose vs Express Lanes



	AM Peak	PM Peak
East Bound	0.2 Min/Mile	0.2 Min/Mile
West Bound	0.2 Min/Mile	0.3 Min/Mile

2045 Peak Period Tolls



Corridor	\$0.80
Per Mile	\$0.13

2045 Annual Toll Revenues



East Bound	\$140,000/mile
West Bound	\$145,000/mile

Estimated Construction Cost



**\$10 - \$15
million/mile**

2045 Employees by Employment Type*

**165,000
TOTAL EMPLOYEES**

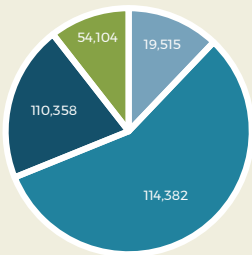

- Industry
- Service
- Office
- Retail

Travel Time Dependability (Buffer Time Index)

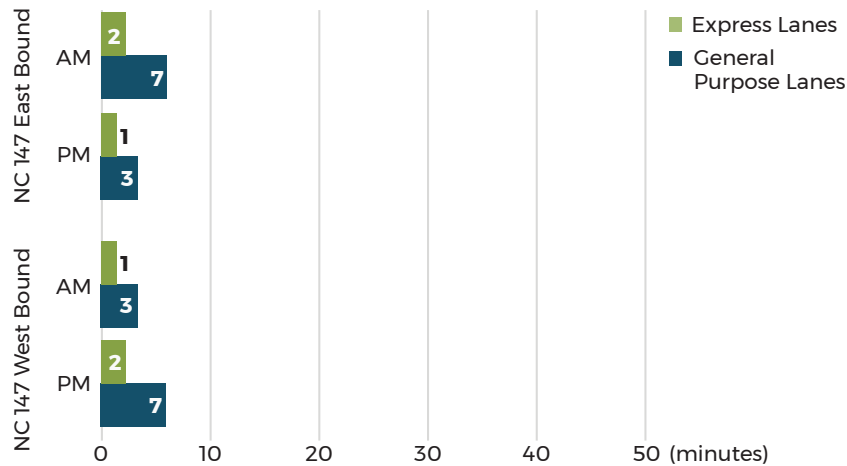

Buffer time is the extra time you must plan for when traveling during times of high traffic to make sure you arrive on time. This could be a trip to work, the airport for a flight, or picking up your child from daycare to avoid the penalty for arriving late. If a trip would take 20 minutes with no traffic, and the buffer time is 30 minutes, you should leave 50 minutes before needing to arrive. Using buffer time, you may arrive early, but it is a way of making sure bad traffic won't make you late.

Routes with high buffer times are less predictable than routes with lower buffer times. The fact that express lanes usually have less buffer time than general purpose lanes shows that express lanes have greater certainty in how it will perform from day to day. This is one of the key features of express lanes.

Percent of the Population Below the Poverty Level*



28%

Future Year Daily Buses**



80

* Within a 2 mile buffer from selected corridor based off the Triangle Regional Model
** Routes that are along some segment of the corridor

TRIANGLE STRATEGIC TOLLING STUDY

US-70

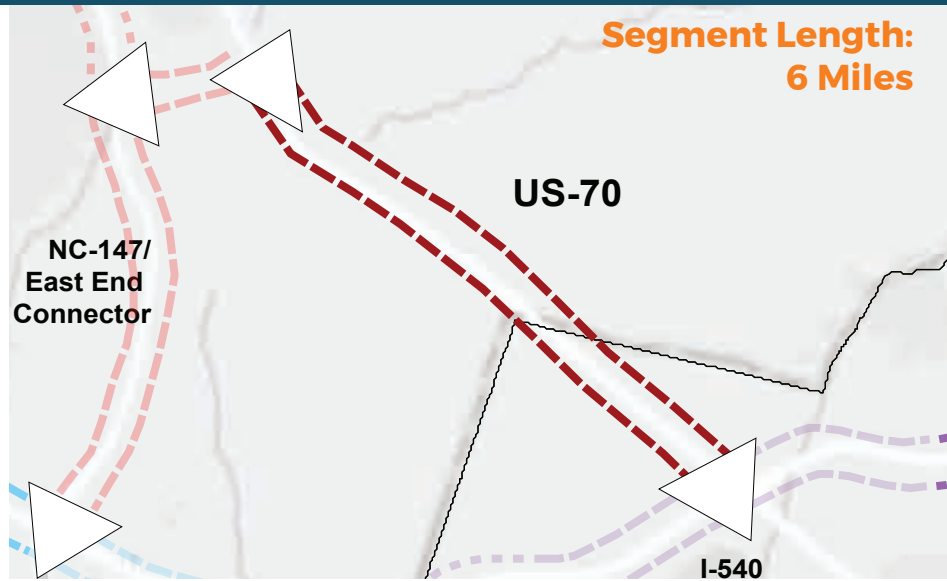
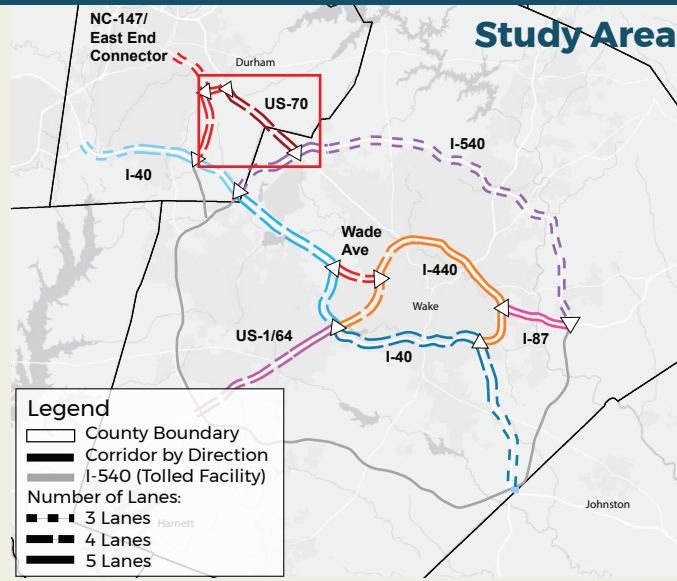

2045 Peak Travel Time Savings General Purpose vs Express Lanes



	AM Peak	PM Peak
East Bound	1.7 Min/Mile	0.7 Min/Mile
West Bound	0.7 Min/Mile	2.2 Min/Mile

2045 Peak Period Tolls



Corridor	\$3.40
Per Mile	\$0.57

2045 Annual Toll Revenues



East Bound	\$265,000/mile
West Bound	\$255,000/mile

Estimated Construction Cost



**\$10 - \$21
million/mile**

2045 Employees by Employment Type*

**60,000
TOTAL EMPLOYEES**

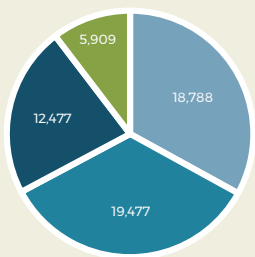

Industry Service
Office Retail

Travel Time Dependability (Buffer Time Index)

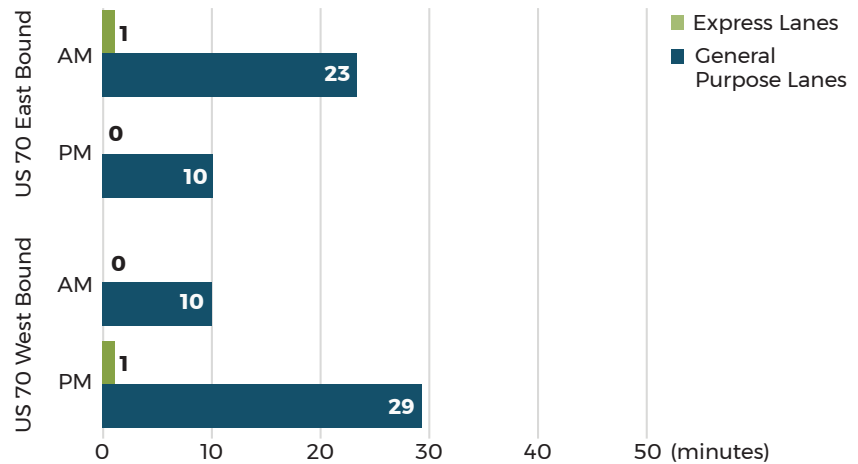

Buffer time is the extra time you must plan for when traveling during times of high traffic to make sure you arrive on time. This could be a trip to work, the airport for a flight, or picking up your child from daycare to avoid the penalty for arriving late. If a trip would take 20 minutes with no traffic, and the buffer time is 30 minutes, you should leave 50 minutes before needing to arrive. Using buffer time, you may arrive early, but it is a way of making sure bad traffic won't make you late.

Routes with high buffer times are less predictable than routes with lower buffer times. The fact that express lanes usually have less buffer time than general purpose lanes shows that express lanes have greater certainty in how it will perform from day to day. This is one of the key features of express lanes.

Percent of the Population Below the Poverty Level*



17%

Future Year Daily Buses**



48

* Within a 2 mile buffer from selected corridor based off the Triangle Regional Model
** Routes that are along some segment of the corridor

TRIANGLE STRATEGIC TOLLING STUDY

WADE AVENUE

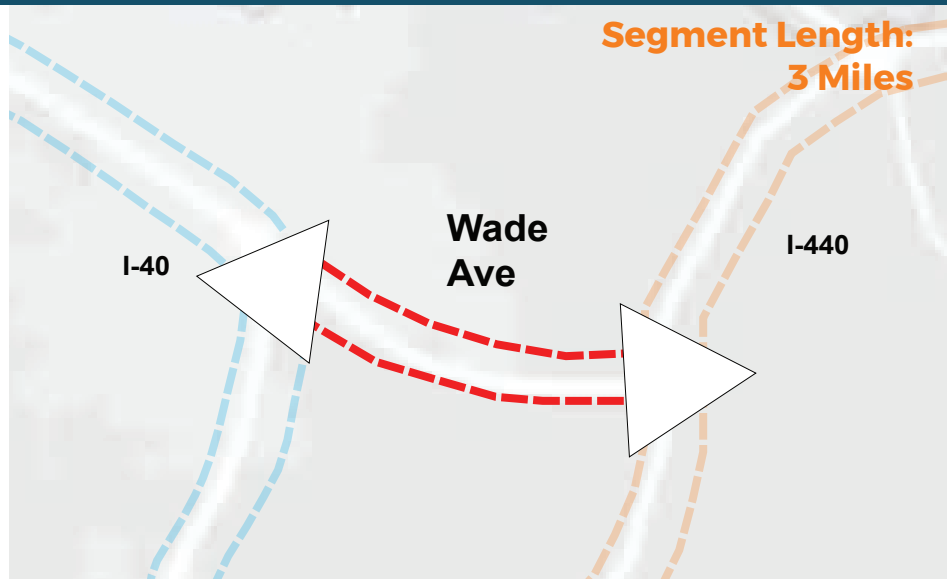
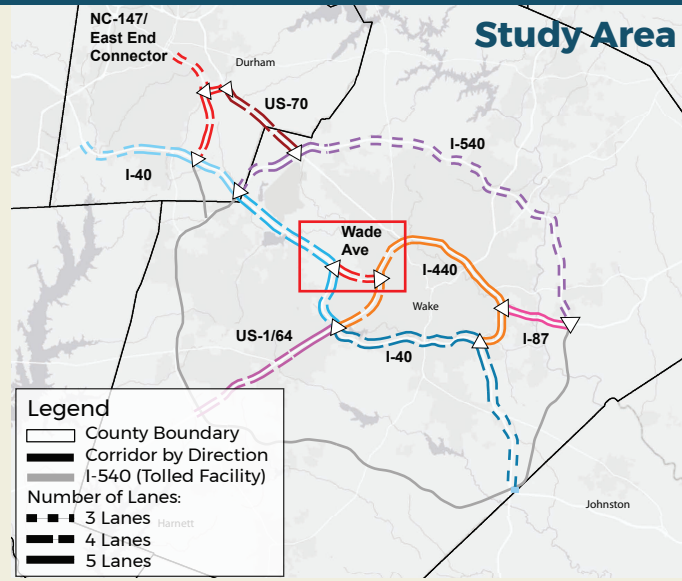

2045 Peak Travel Time Savings General Purpose vs Express Lanes



AM Peak PM Peak

East Bound West Bound

No Savings

2045 Peak Period Tolls



Corridor **\$0.15**

Per Mile **\$0.05**

2045 Annual Toll Revenues



East Bound **\$105,000/mile**

West Bound **\$45,000/mile**

Estimated Construction Cost



\$10 - \$14 million/mile

2045 Employees by Employment Type*

105,000
TOTAL EMPLOYEES

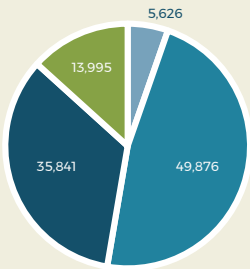

Industry Service
Office Retail

Travel Time Dependability (Buffer Time Index)

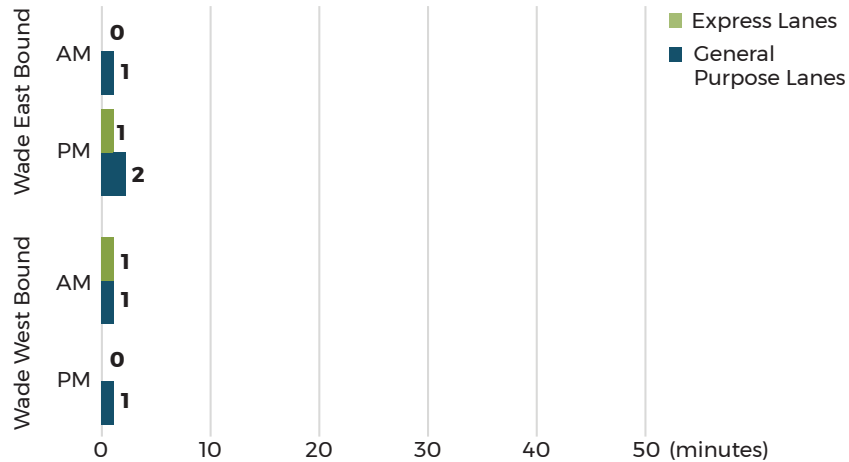

Buffer time is the extra time you must plan for when traveling during times of high traffic to make sure you arrive on time. This could be a trip to work, the airport for a flight, or picking up your child from daycare to avoid the penalty for arriving late. If a trip would take 20 minutes with no traffic, and the buffer time is 30 minutes, you should leave 50 minutes before needing to arrive. Using buffer time, you may arrive early, but it is a way of making sure bad traffic won't make you late.

Routes with high buffer times are less predictable than routes with lower buffer times. The fact that express lanes usually have less buffer time than general purpose lanes shows that express lanes have greater certainty in how it will perform from day to day. This is one of the key features of express lanes.

Percent of the Population Below the Poverty Level*



20%

Future Year Daily Buses**



88

* Within a 2 mile buffer from selected corridor based off the Triangle Regional Model
** Routes that are along some segment of the corridor

06 **STAKEHOLDER ENGAGEMENT**

6 STAKEHOLDER ENGAGEMENT

This section summarizes the outreach efforts undertaken during the Triangle Strategic Tolling Study. The primary focus of the study’s engagement efforts was to inform key stakeholders about tolling and express lanes. The following sections describe stakeholder activities over the study period.

6.1 CORE TECHNICAL TEAM

The Core Technical Team (CTT) consisted of 21 members who represented CAMPO, CTDCHC MPO and NCDOT. This group’s purpose was to review the study’s technical products and provide comments. Table 6-1 lists the group’s members.

Table 6-1 CTT Members

Name	Organization
Chris Lukasina	Capital Area Metropolitan Planning Organization
Shelby Powell	Capital Area Metropolitan Planning Organization
Alex Rickard	Capital Area Metropolitan Planning Organization
Paul Black	Capital Area Metropolitan Planning Organization
Kenneth Withrow	Capital Area Metropolitan Planning Organization
Bonnie Parker	Capital Area Metropolitan Planning Organization
Felix Nwoko	Durham-Chapel Hill-Carrboro Metropolitan Planning Organization
Andy Henry	Durham-Chapel Hill-Carrboro Metropolitan Planning Organization
Yanping Zhang	Durham- Chapel Hill-Carrboro Metropolitan Planning Organization
Kosok Chae	Durham-Chapel Hill-Carrboro Metropolitan Planning Organization
Derrick Lewis	North Carolina Department of Transportation
Richard Hancock	North Carolina Department of Transportation
David Keilson	North Carolina Department of Transportation
Scott Walston	North Carolina Department of Transportation
Doumit Ishak	North Carolina Department of Transportation
Clarence Bunting	North Carolina Department of Transportation
Andy Lelewski	North Carolina Turnpike Authority
Dennis Jernigan	North Carolina Turnpike Authority
Keith Holliday	North Carolina Turnpike Authority
Kendra Parrish	Town of Holly Springs
Ben Howell	Town of Morrisville
Joe Milazzo	Triangle Regional Transportation Alliance

Table 6-2 lists the four CTT and two special purpose meetings held at CAMPO offices during the study.

Table 6-2 CTT Meeting Details

Meetings	Date	Agenda Items
Kick-Off Meeting	6/7/17	<ul style="list-style-type: none"> – Work Plan & Schedule – Initial Data Needs – Public Engagement – SOT Workshop #1 Purpose, Invitees & Scheduling
Public Engagement	9/19/17	<ul style="list-style-type: none"> – Project Website – One-on-One Stakeholder Meetings – SOT Workshop #1
CTT Meeting #2	11/17/17	<ul style="list-style-type: none"> – Best Practices Memo Highlights – Project Website – One-on-One Stakeholder Meetings – SOT Workshop #1
Review of Proposed Corridors	5/17/18	<ul style="list-style-type: none"> – Initial Screening Criteria – Screening Analysis Process – Review Corridors Proposed for Tier 2 Screening
CTT Meeting #3	8/23/18	<ul style="list-style-type: none"> – Policy Considerations & Performance Measures – TOM Results for Proposed Corridors – Next Steps in Corridor Screening
CTT Meeting #4	2/22/19	<ul style="list-style-type: none"> – Tier 2 Screening Review – Toll Revenues & Transit Supportive – Travel Time Savings & Trip Dependability – Construction Costs – Impacts on Low Income Residents – Discussion of Tier 2 Findings

6.2 STAKEHOLDER OVERSIGHT TEAM

The Stakeholder Oversight Team (SOT) was comprised of 30 representatives of partner agencies with an interest in transportation planning and capital improvements. The SOT provided another perspective on the study's technical products and offered new insights. Table 6-3 lists the group's membership.

Table 6-3 Stakeholder Oversight Team Members

Names	Organizations
Bergen Watterson	Town of Chapel Hill
Tim Brock	Research Triangle Park
Geoff Green	Go Triangle
John Hodges-Copple	Triangle J Council of Governments
George List	N.C. State University
Natalie Britt	Durham
George Hoops	Federal Highway Administration
Chris Hills	Town of Knightdale
Reginald Johnson	City of Durham Department of Community Development
Elvert Dorsey	Durham Housing Authority
Wayne Felton	Raleigh Housing Authority
Justin Jorgensen	Granville County Planning Department
Kym Hunter	Southern Environmental Law Center
Kelly Junker	City of Raleigh
Aaron Nelson	Carolina Chamber
Chip Russell	Town of Wake Forest
Nishith Trivedi	Orange County
Scott Whiteman	Durham County
Julie Bogle	North Carolina Department of Transportation
Greg Burns	North Carolina Department of Transportation
Lynise DeVance	FHWA-North Carolina Office
Joey Hopkins	North Carolina Department of Transportation
Terry Hutchens	North Carolina Department of Transportation
Jamal Alavi	North Carolina Department of Transportation
Brandon Jones	North Carolina Department of Transportation
Valerie Jordan	North Carolina Board of Transportation
Mike Mills	North Carolina Department of Transportation
Gus Tulloss	North Carolina Board of Transportation
Rodger Rochelle	North Carolina Turnpike Authority

Table 6-4 provides details on the three SOT meetings.

Table 6-4 SOT Meeting Details

Meetings	Date	Location	Agenda Items
Meeting #1	3/7/18	Research Triangle Park Headquarters	<ul style="list-style-type: none"> – Triangle Region Conditions & Trends – Tolling & Express lanes Overview – Stakeholder Meeting Themes – Policy Considerations & Potential Performance Measures
Meeting #2	9/20/18	Triangle J Council of Governments	<ul style="list-style-type: none"> – Latest Trends in U.S. Tolling & Express lanes Practices – Initial Corridor Screening Results – Policy Considerations & Potential Performance Measures – Next Steps in Corridor Screening
Meeting #3	4/11/19	Triangle J Council of Governments	<ul style="list-style-type: none"> – Review Preliminary Screening Results – Tier 2 Corridor Evaluation Criteria – Review Tier 2 Corridors – Feedback on Upcoming Presentations

6.3 STAKEHOLDER INTERVIEWS

As part of the community outreach effort, stakeholder interviews were conducted with regional leaders in January 2018. The meetings ranged from individual discussions to sessions with multiple participants. The purpose of the interviews was to identify initial perceptions of tolling as a strategy to address mobility problems. The interviewees represented a broad cross-section of perspectives across the region. Meeting participants were asked to wear two hats: first, as a member of your industry and second, as a resident of the community with family and household needs – both critical to shaping a future in which everyone thrives. Table 6-5 lists the 23 persons who attended the sessions.

Table 6-5 Stakeholder Interviewees

Date	Location	Participant(s)
1/22/18	NCDOT Transportation Building	<ul style="list-style-type: none"> – Secretary Jim Trogdon – Beau Memory – Joey Hopkins
1/22/18	FHWA Division Offices	<ul style="list-style-type: none"> – Lynise DeVance
1/23/18	John Locke Foundation Offices	<ul style="list-style-type: none"> – Joe Coletti
1/23/18	Triangle J COG	<ul style="list-style-type: none"> – Michael Grannis, Town of Clayton – Vivian Jones, Town of Wake Forest – Heidi Carter, Durham County – Michael Parker, Town of Chapel Hill – Barry Jacobs, Orange County – Charlie Reece, City of Durham – Will Allen, GoTriangle – Joe Milazzo, Regional Transportation Alliance
1/23/18	Triangle J COG	<ul style="list-style-type: none"> – Kym Hunter, Southern Environmental Law Center – Matt Walker, Durham Department of Community Development
1/24/18	Triangle J COG	<ul style="list-style-type: none"> – Derrick Lewis, NCDOT – Richard Hancock, NCDOT – David Keilson, NCDOT – Tim Maloney, Wake County – Ellen Beckmann, City of Durham – Andy Henry, DCHC MPO – George List, N.C. State University – Bergen Watterson, Town of Chapel Hill – Dylan Bruchhaus, Town of Morrisville
3/6/18	City of Raleigh	<ul style="list-style-type: none"> – Eric Lamb

Participants were asked a series of questions and responded anonymously through electronic polling to give everyone equal opportunity to provide their input. Each question was followed up with discussion as needed to clarify comments or pull more information. Participants prioritized the current community issues potentially impacting the perception of tolling and/or implementing express toll lanes in the Triangle as shown in Figure 6-1. The word cloud shows responses based on the number of times those responses were mentioned or “voted” on by stakeholders.



Figure 6-1 Word Cloud on Community Issues Potentially Impacting the Perception of Tolling/Express Toll Lanes in the Triangle

Interviewees suggested the following as the biggest opportunities for improving the perception of tolling during the study:



Figure 6-2 Biggest Opportunities for Improving the Perception of Tolling

Participants highlighted the following outreach and education topics as focal points during the study:

- Clear communication of benefits
- Express lanes are a choice (no free options are eliminated)
- Variety of ways and types to finance toll/express lanes
- Variety of ways to operate toll/express lanes (discounts, subsidies, HOV, etc.)
- Tolling options
- Funding of road improvements in the Triangle
- Need for toll/express lanes and the benefits compared to adding more general purpose lanes
- Awareness of funding changes for transportation projects

Stakeholders offered strategies for mitigating the impacts or perceived problems with tolling and express lanes.



Figure 6-3 Strategies for Mitigating the Impacts or Perceived Problems with Tolling/Express Lanes

Stakeholders were asked about their views on potential environmental benefits/concerns; responses are shown in Figure 6-4:



Figure 6-4 Potential Environmental Benefits/Concerns

6.4 PARTNER AND STAKEHOLDER ORGANIZATION PRESENTATIONS

Throughout the study, stakeholder groups were briefed on national experience with tolling and express lanes operations and project activities. Table 6-6 summarizes presentations made to stakeholder organizations.

Table 6-6 Presentation Details

Date	Group	Location
10/30/16	Joint Meeting of CAMPO and DCHC Executive Boards	Friday Center, UNC-Chapel Hill
10/31/18	Joint Meeting of CAMPO and DCHC Executive Boards	Research Triangle Park Headquarters
5/2/19	North Carolina Turnpike Authority Board of Directors	NCDOT Transportation Building
5/16/19	Federal & State Transportation Staff	CAMPO Offices
5/29/19	Joint Meeting of CAMPO and DCHC Executive Boards	Research Triangle Park Headquarters
6/12/19	DCHC MPO Executive Board	Durham City Hall
6/19/19	CAMPO Executive Board	CAMPO Offices

6.5 WEBSITE

A public website (<http://triangleollingstudy.com/>) was established for the study. The website was a comprehensive source of project information, as well as a means for the public to communicate with the Study Team. The website offered information on the study’s status, presentations given at stakeholder meetings, a glossary of terms and Frequently Asked Questions.

In addition to providing project-specific information, the website included videos explaining express lane use in other areas of the country. The site also provided links to CAMPO and DCHC MPO Twitter accounts.

Since the launch of the website, there have been over 360 users. Of that, 87 percent were new users. The website statistics are as follows:



TRIANGLE STRATEGIC TOLLING STUDY
NC CAMPO | DCHC MPO | NCDOT

ABOUT THE STUDY

FAQS

GLOSSARY OF TERMS

RESOURCES LIBRARY

CONTACT US

LATEST NEWS

NC CAMPO

DCHC MPO



State Route 91 in California: Pylon Separators Between Express Toll Lanes and General Purpose Lanes

○ ● ○ ○ ○

What is the Triangle Strategic Tolling Study?

The Triangle Region is one of the fastest growing in the country. This growth creates ongoing challenges for how we plan land use, transportation

Latest News

OCTOBER 2018
A presentation of the Triangle Strategic Tolling Study was given during the Joint Capital Area MPO/Durham-Chapel Hill-Carrboro MPO Executive Board meeting on Wednesday, October 31 at RTP Headquarters. [View the presentation.](#)

SEPTEMBER 2018
The Stakeholder Oversight Team presentation is available in the [Resource Library!](#)

AUGUST 2018
Informational Toll Video: [I-485 Express Lanes: A Better Way](#)

MARCH 2018
Visit our Resource Library to view the [Triangle Strategic Tolling Study Managed Lane & Tolling Best Practice Report](#) and the [March 2018 Stakeholder Oversight Team Meeting Presentation.](#)

MARCH 2018
Visit the [FAQs](#) to learn more about tolling.

[SIGN UP FOR EMAIL UPDATES >](#)

Videos

Learn more about express toll lanes from projects implemented in other areas:

Open Road Tolling by NC Turnpike Authority

Figure 6-5 Website for the Study - www.triangletollingstudy.com

REFERENCES

- Federal Highway Administration. *Manual on Uniform Traffic Control Devices*, 2009
- Federal Highway Administration, 2012. Priced Managed Lane Guide.
- Newmark, Gregory 2014. HOT for Transit? Transit's Experience of High-Occupancy Toll Lanes in the *Journal of Public Transportation* 17 (3): 97-114.
- Southern California Association of Governments (SCAG). *Regional Concept of Operations*, September 2017
- Sullivan, Edward, 2000. Continuation Study to Evaluate the Impacts of the SR 91 Value-Priced Express Lanes. Final Report. State of California, Department of Transportation, Traffic Operations Program. HOV Systems Branch, Sacramento. December.
- University of California at Berkeley. *A Comparative Safety Study of Limited versus Continuous Access HOV Facilities*, Task Order 6601 Traffic Safety Center, September 2007
- U.S. Department of Transportation, Federal Highway Administration, December 2008. Income-Based Equity Impacts of Congestion Pricing, A Primer
- U.S. Department of Transportation, Federal Highway Administration, April 2013. Guidebook for State, Regional, and Local Governments on Addressing Potential Equity Impacts of Road Pricing.
- U.S. Department of Transportation 2014. Los Angeles Congestion Reduction Demonstration (LA CRD) ExpressLanes Program; National Evaluation: Technical Memorandum on Congestion, Tolling, Transit, and Equity Results.
- Zmud, J. and C. Arce. 2008. NCHRP Synthesis 377. Compilation of Public Opinion Data on Tolls and Road Pricing. Transportation Research Board of the National Academies, Washington D.C.

07 APPENDIX

APPENDIX A: CORRIDOR CROSS-SECTIONS

A.1 I-40 WEST CROSS-SECTIONS

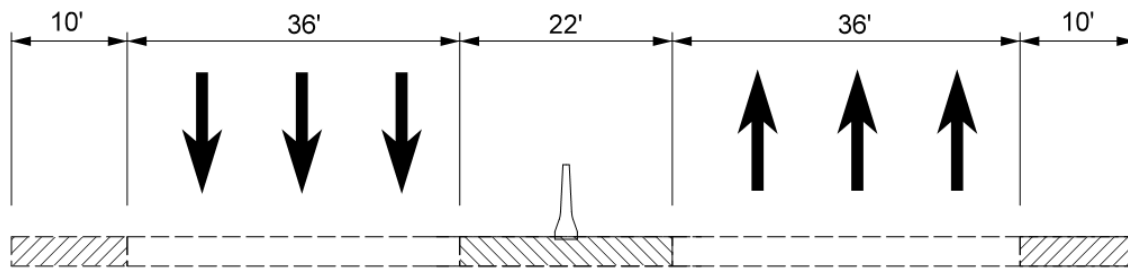

Figure A-1 Existing Typical Section

- 6-Lane w/ 22' median
- 6.4 Miles
- Excludes I-5702A (Express lanes)

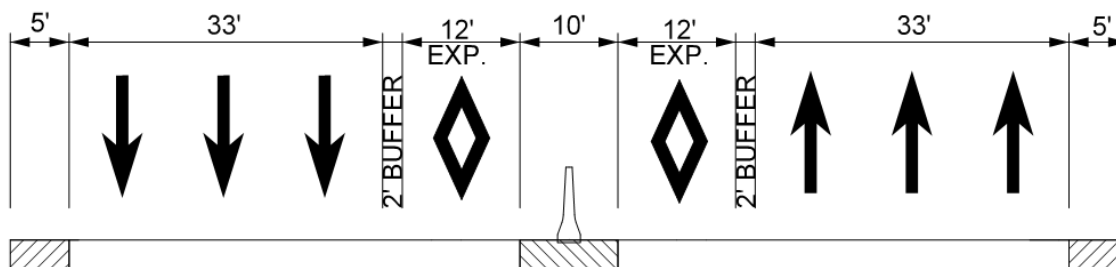

Figure A-2 Constrained Section

- 6 GP w/ 2 Express lanes
- Lane widths reduced to 11'
- Median reduced to 10' w/ 2' buffer
- Reduced outside shoulders

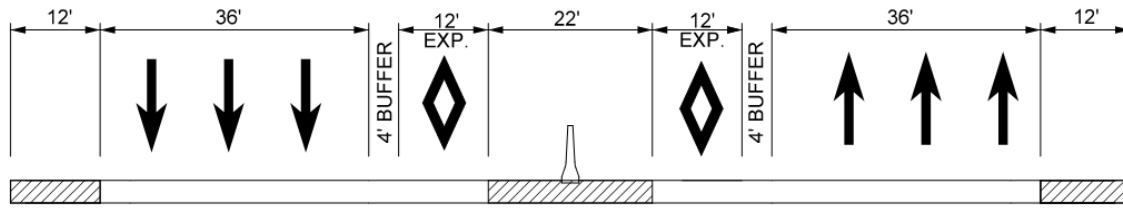

Figure A-3 Full Feature Section

- 6 GP w/ 2 Express lanes and 22' Median
- 4' Buffer
- 12' Outside Shoulders

A.2 I-40 CENTRAL CROSS-SECTIONS

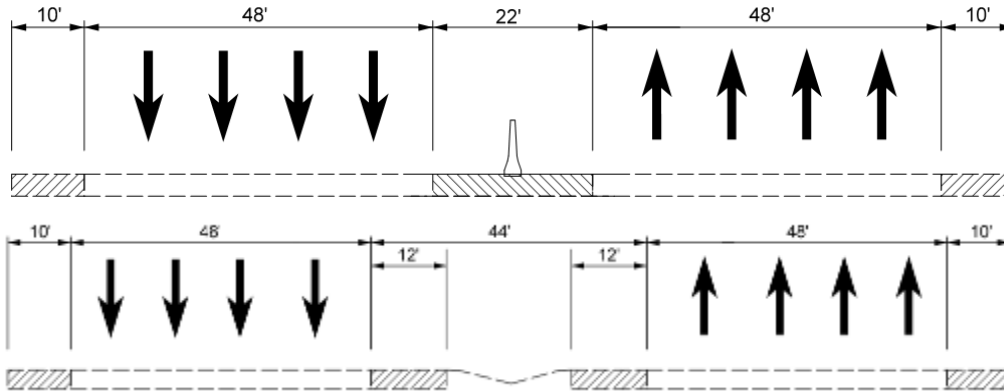

Figure A-4 Existing Typical Section

- 8-Lane w/ 22'+/- median
- Includes I-5704 (widening to 8 lanes)
- Excludes Express Lane projects (I-5702)
- 13.5 Miles

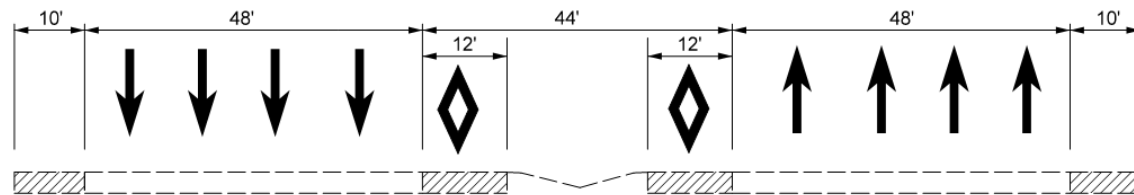

Figure A-5 Shoulder Use (portion) Section

- Applicable to 3.8 miles of 13.5 miles

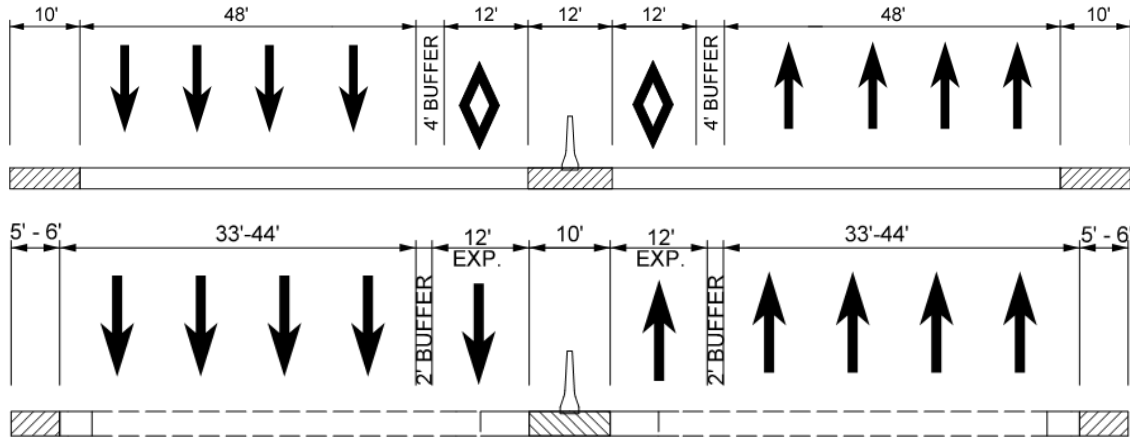

Figure A-6 Constrained Section

- 8 GP w/ 2 Express lanes
- Lane widths reduced to 11'
- Median reduced to 10'
- 2' Buffers
- Reduced outside shoulders

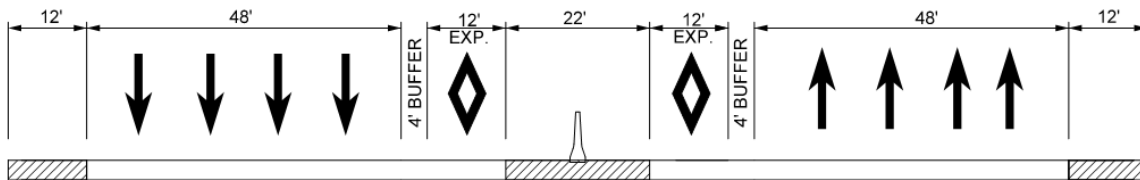

Figure A-7 Full Feature Section

- 8 GP w/ 2 Express lanes and 22' median
- 4' Buffer
- 12' outside shoulders

A.3 I-40 SOUTH CROSS-SECTIONS

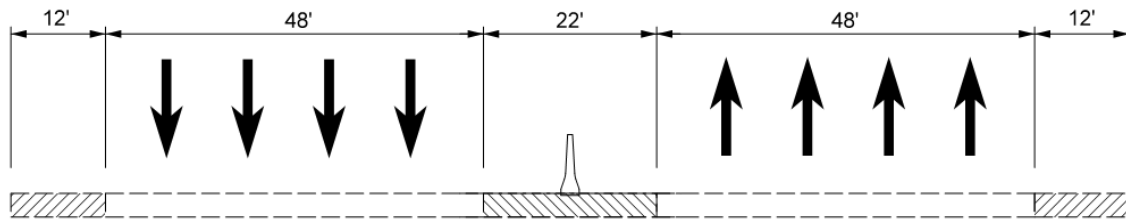

Figure A-8 Existing Typical Section

- 8-Lane w/ 22' median
- Accommodations with I-5111
- Includes I-5701
- 17.1 Miles

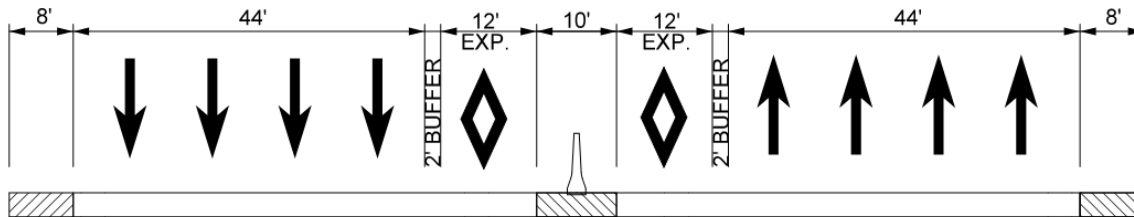
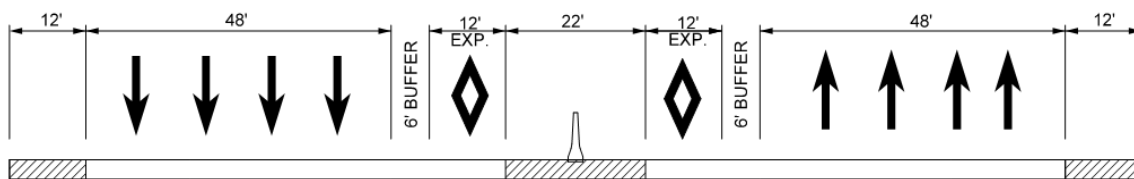

Figure A-9 Constrained Cross Section

- 8 GP w/ 2 Express lanes
- Lane widths reduced to 11'
- Median reduced to 10' w/ 2' buffer
- Reduced outside shoulders



AS ACCOMMODATED WITHIN I-5111

Figure A-10 Full Feature Section

- 8 GP w/ 2 Express lanes and 22' median
- 4' to 6' buffer
- 12' outside shoulders

A.4 I-440 CROSS-SECTIONS

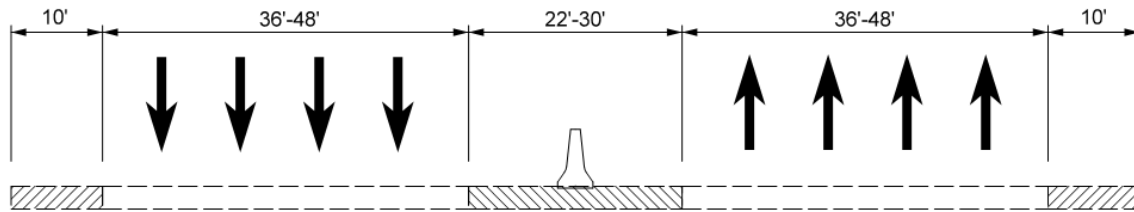

Figure A-11 Existing Typical Section

- 6 or 8-Lane w/ 22' median
- 16.5 Miles

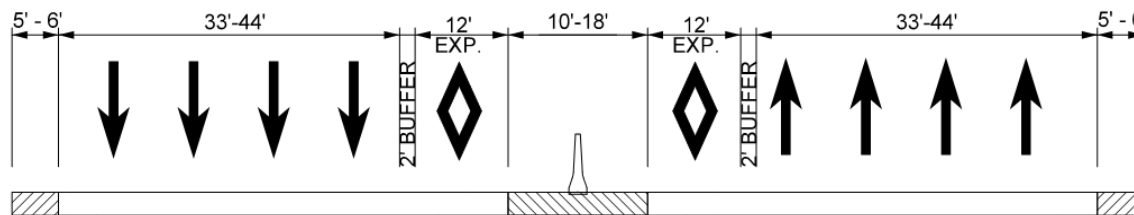

Figure A-12 Constrained Section

- 6 or 8 GP w/ 2 Express lanes
- Median reduced to 10' w/ 2' buffer
- Reduced outside shoulders

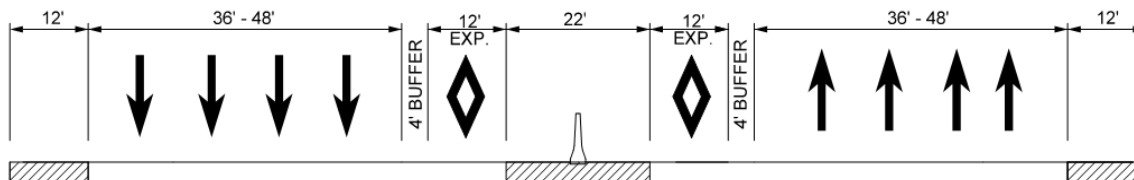

Figure A-13 Full Feature Section

- 6 or 8 GP w/ 2 Express lanes w/ 22' Median
- 4' buffer
- 12' outside shoulders

A.5 I-540 CROSS-SECTIONS

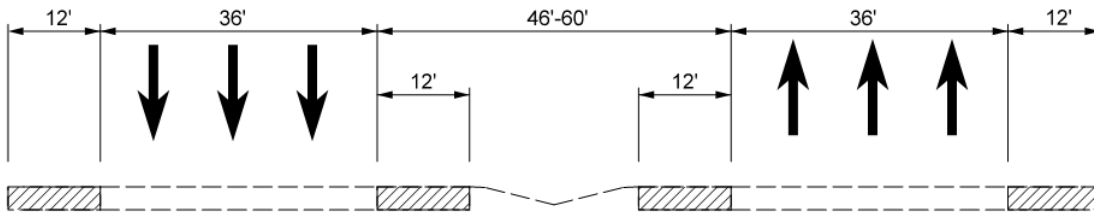

Figure A-14 Existing Typical Section

- 6-Lane w/ 46' min. median
- 25.6 miles

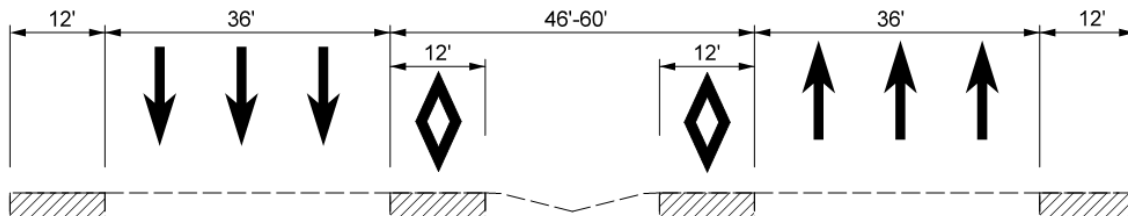

Figure A-15 Shoulder Use Option Section

- I-5982 (2025)

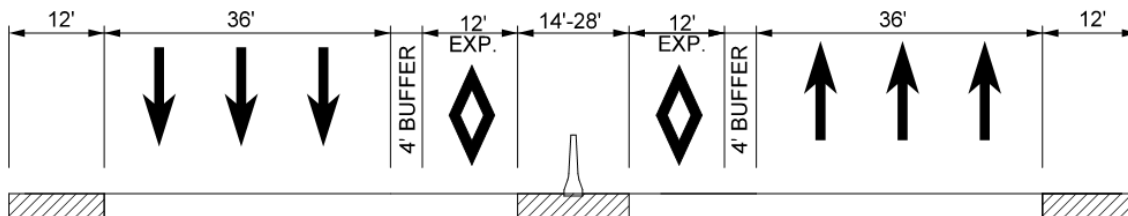

Figure A-16 Constrained Section

- 6 GP w/ 2 Express lanes
- Median reduced to 14'
- 4' buffer

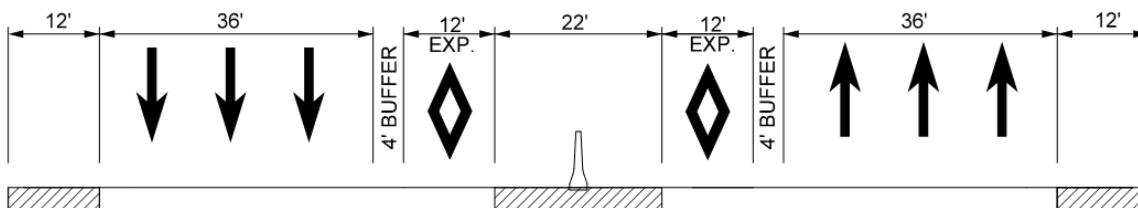

Figure A-17 Full Feature Section

- 6 GP w/ 2 Express lanes
- 22' median
- 4' buffer

A.6 US-1/US-64 CROSS-SECTIONS

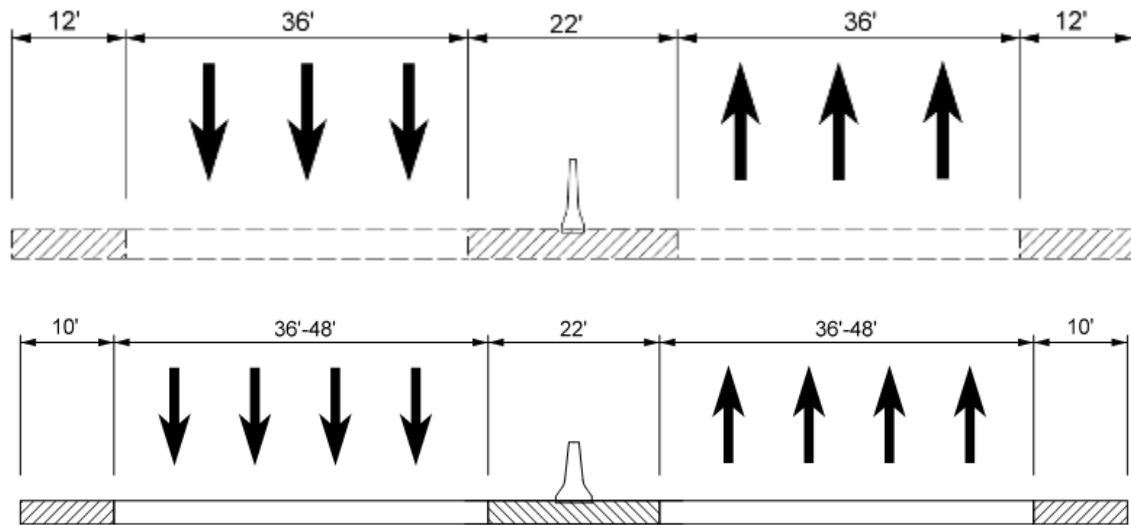

Figure A-18 Existing Typical Section

- Includes widening of US-1 to NC 540 to US 64
- 6 to 8-lane divided
- 9.1 Miles

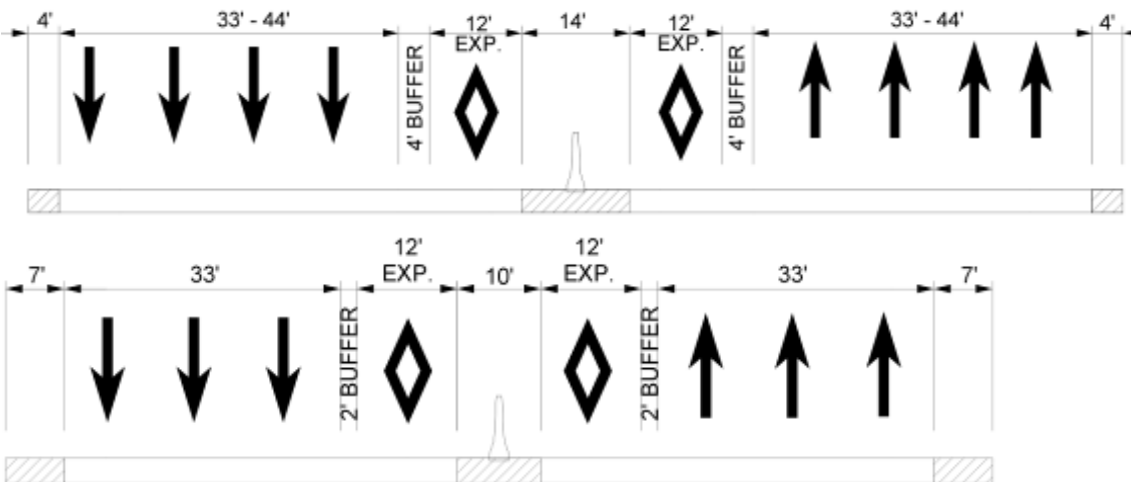

Figure A-19 Constrained Section

- 6-8 GP w/ 2 Express lanes
- Median reduced to 10'-14'
- 11' lanes
- 2' buffer
- Reduced outside shoulders

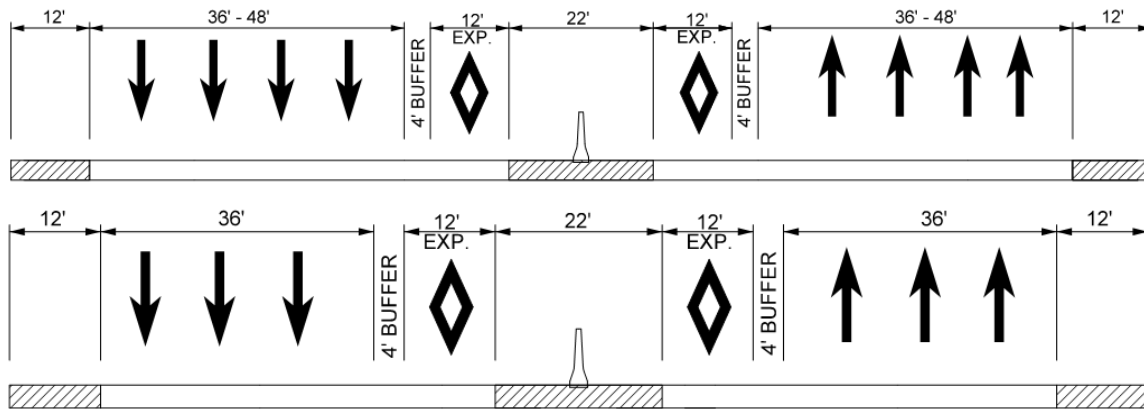

Figure A-20 Full Feature Section

- 6-8 GP w/ 2 Express lanes
- 22' median
- 4' buffer
- 12' outside shoulders
- Interchange Reconstructions

A.7 I-87 CROSS-SECTIONS

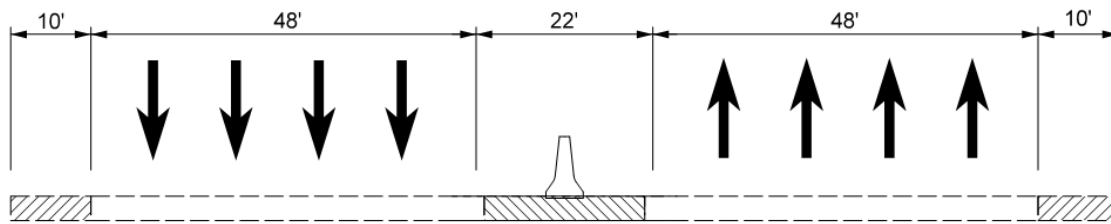

Figure A-21 Existing Typical Section

- 2035 - 8-Lane w/ 22' median
- 3.8 miles

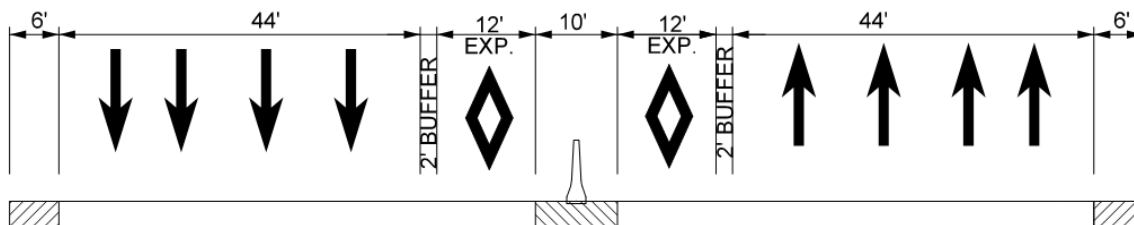

Figure A-22 Constrained Section

- 8 GP w/ 2 Express lanes
- 11' travel lanes
- Median reduced to 10'
- 2' buffer

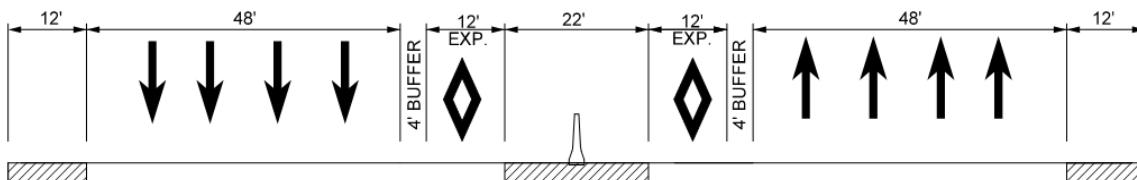

Figure A-23 Full Feature Section

- 8 GP w/ 2 Express lanes
- 22' median
- 4' buffer

A.8 NC-147 CROSS-SECTIONS

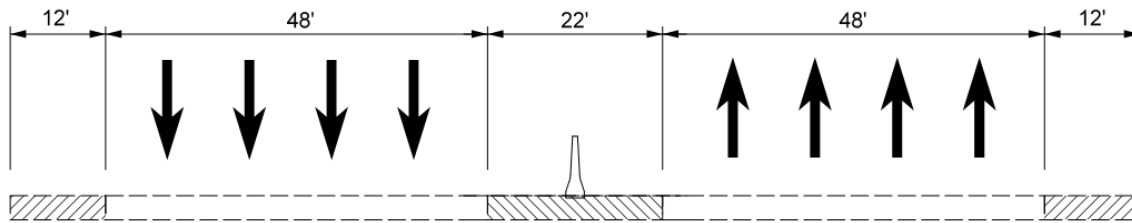

Figure A-24 Existing Typical Section

- 8-Lane w/ 22' median
- Includes U-5934 (2022)
- 4.8 miles

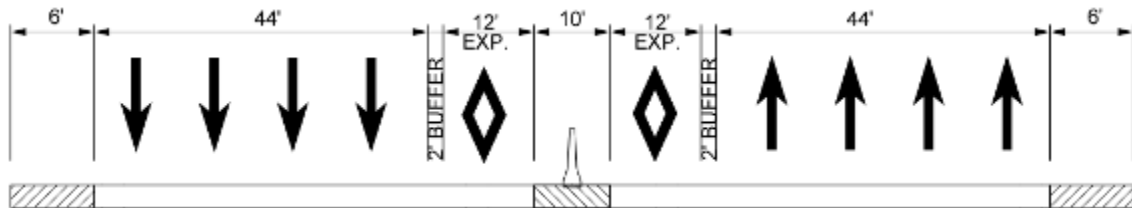

Figure A-25 Constrained Section

- 8 GP w/ 2 Express lanes
- 10' median
- 2' buffer

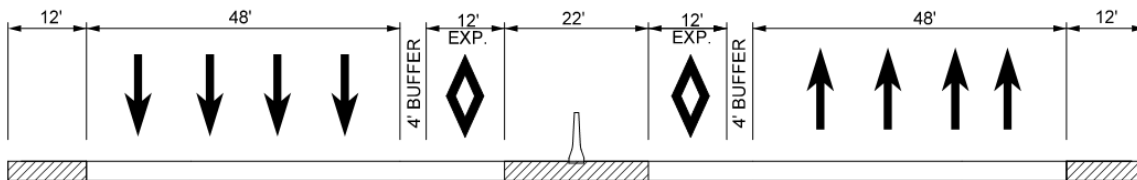
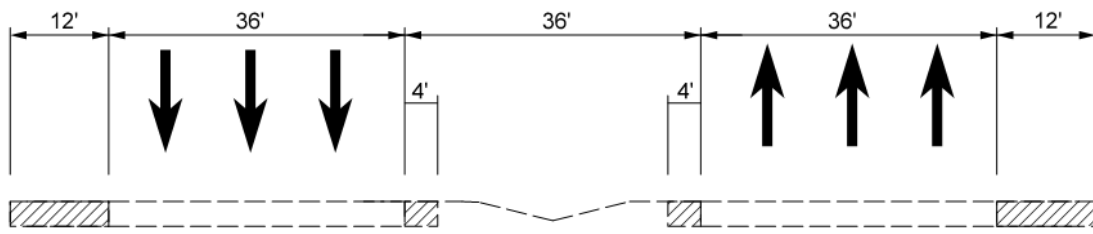

Figure A-26 Full Feature Section

- 8 GP w/ 2 Express lanes and 22' median
- 4' buffer
- 12' outside shoulders

A.9 US-70 CROSS-SECTIONS



AS CONSTRUCTED WITH U-5720

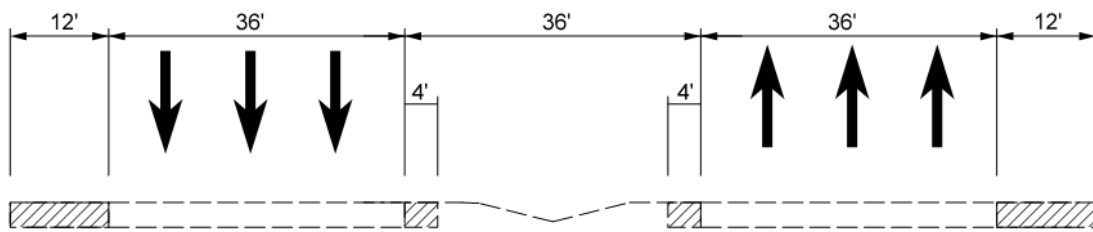

AS CONSTRUCTED WITH U-5720

Figure A-27 Existing Typical Section

- 6-Lane Divided
- Includes Projects U-5518 & U-5720
- 26 to 36' median
- 6.6 Miles

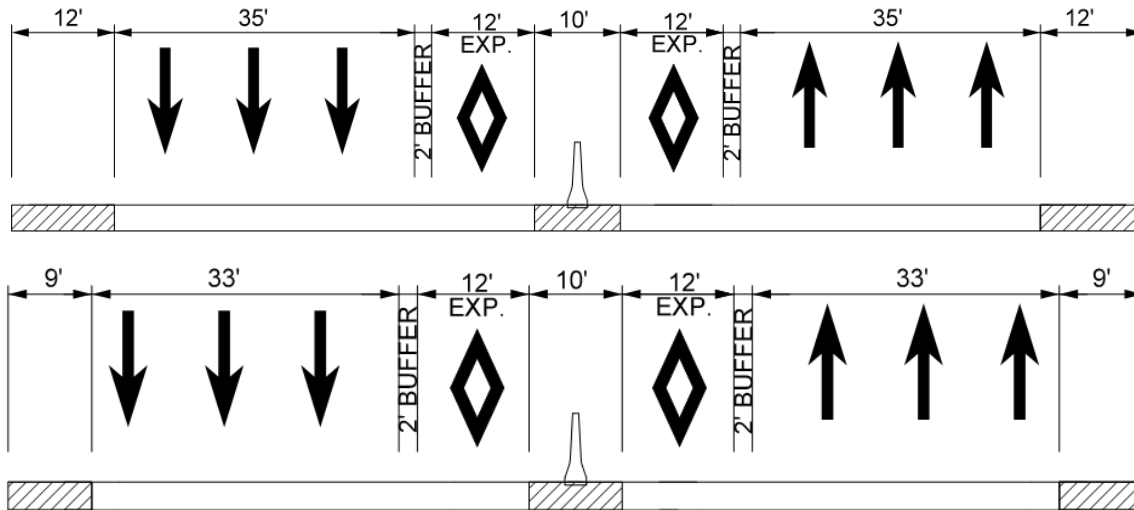

Figure A-28 Constrained Section

- 6 GP w/ 2 Express lanes
- Median reduced to 10'
- 11' lanes
- 2' buffer
- Reduced outside shoulders

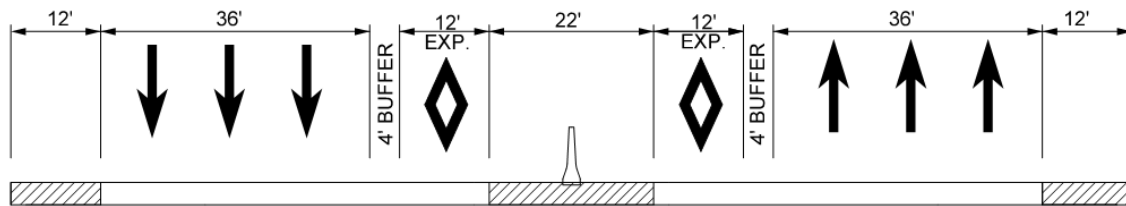

Figure A-29 Full Feature Section

- 6 GP w/ 2 Express lanes
- 22' median
- 4' buffer
- 12' outside shoulders

A.10 WADE AVENUE CROSS-SECTIONS

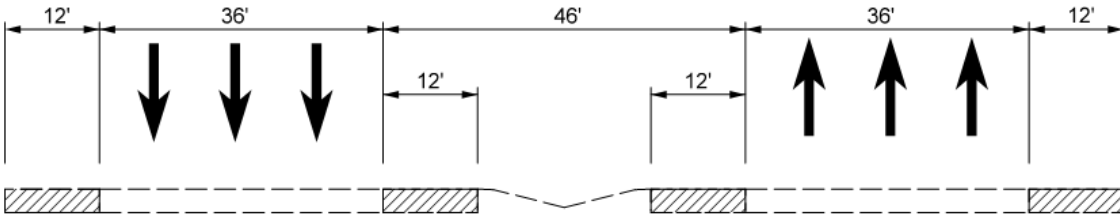

Figure A-30 Existing Typical Section

- 6-Lane w/ 46' min. median
- 2.8 miles

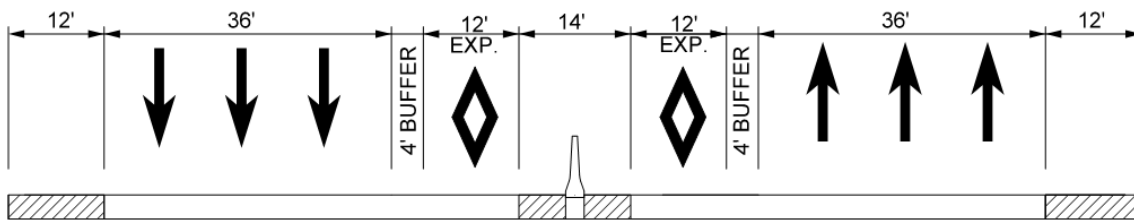

Figure A-31 Constrained Section

- 6 GP w/ 2 Express lanes
- Median reduced to 14'
- 4' buffer

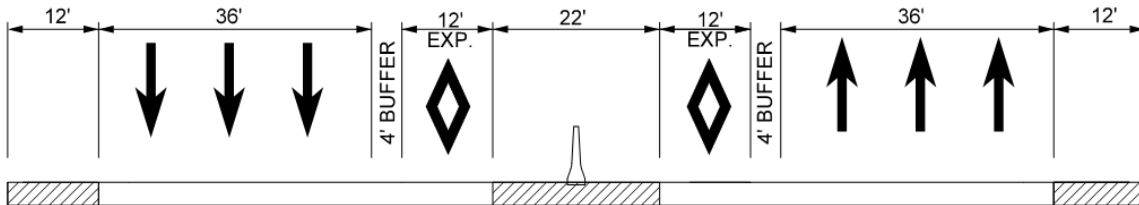

Figure A-32 Full Feature Section

- 6 GP w/ 2 Express lanes
- 22' median
- 4' buffer

TRIANGLE STRATEGIC TOLLING STUDY

Prepared for:



DURHAM - CHAPEL HILL - CARRBORO



Prepared by:

